



Instruction manual
nextGeneration
6.30-X, 7.36-X, 10.36-X
Software version V 1.50 and higher

Microprocessor controlled
Quick charger, Discharger, Capacity tester
Battery conditioner
for sealed Ni-Cd-, Ni-MH-, Lead- (Lead-Acid, Lead-Gel)
and Lithium-Batteries (Li-FePO4, Li-Ion, Li-Po)

- Graphical display of charge voltage
- Data transfer interface for personal computer (PC)
 - „Full“ display by buzzer
- Integrated electronic discharge load
- Internal fan, temperature controlled



Contents

Chapter	Topic	Page
1	General information	2
2	General remarks and precautions	3
3	Commonly used terms	5
4	Useful information about batteries and maintenance	6
5	Mounting instructions CE ring	10
6	Functions	10
7	The first step	11
8	Nickel- (Ni-Cd/Ni-MH) battery programs	16
9	Lead- (Pb = lead-acid/lead-gel) battery programs	19
10	Lithium- (Li-Fe, Li-Ion, Li-Po) battery programs	20
11	Charging/discharging of Ni-Cd / Ni-MH transmitter batteries	21
12	Hints (plug-in proceeding / charging/discharging of 1-3 cells / storing)	21
13	The "full" cut-off menu	22
14	Battery monitoring and safety facilities	23
15	Monitoring functions on LCD-panel	27
16	Special adjustments (inclusively Motor Run-In)	28
17	Energy re-transfer function	32
18	Writing/reading your configurations	32
19	Additional sockets (on the right side)	33
20	Protection circuits, error-messages and warnings	34
21	Important notes	36
22	Legal matters	38
23	Menu overview	39
24	Standard ready made configurations	42
25	Standard setup charge- and discharge programs	42
26	PC interface data format	43
27	PC interface pin codes	44
28	Balancing connectors and measuring inputs	44
29	Additional sockets on the right side pin codes	46
30	Specifications	46
31	Installing the nextConn module	48
32	Installation of the USB-driver on the PC	49
Annex	Trouble shooting / service questionnaire	TS, SQ

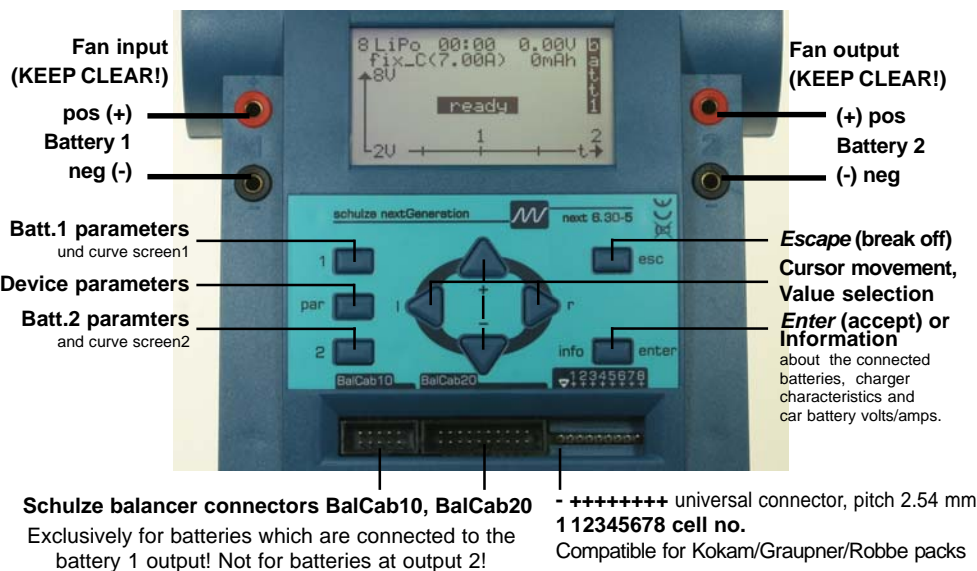

1 General information

Congratulations! With the **nextGeneration** you have purchased a top of the line product made in Germany. Reliable SMD technology, outstanding performance and flexibility and last but not least their easy handling and the new technological features you will have a lot of fun with it. By using the up-to-date electronic devices (at the moment of the development) and a new discharge circuit which re-transfers energy into the car battery from only one cell and higher, the **nextGeneration** has become even more powerful and flexible than all our predecessors. We are convinced that the charger sets new standards for battery charging technology.

The **nextGeneration** requires no maintenance, but needs to be protected against dust and moisture. Openings in the housing are essential for cooling and must not be blocked!

The **nextGeneration** provides best operating comfort and maximum reliability. Using the patented **automaticC** charging option for **Ni-Cd and Ni-MH batteries**, you will notice that the microprocessor inside will charge your batteries as fast as possible, yet as carefully as necessary (don't be worried about the relatively high start current of the Ni-MH current calculation automatic).

Additionally you can discharge your batteries, measure their capacity and condition them. Same options are available for sintered Ni-Cd, Ni-MH batteries.

Both outputs may be in use at the same time and independent from each other.

The graphical LCD (Liquid-Crystal-Display) panel is new for this type of chargers and provides a visual representation of the charge voltage curve relative to time, in addition to the display of charge data in alpha-numeric form.

The unit also enables you to transfer the charge data on-line to a home computer, where it can be displayed and analysed using the "Akkusoft" software, written by Martin Adler.

In order to make full use of your new charger we strongly recommend you to read the Instruction Manual page by page and take note of the hints. Although the supplied text is rather long, there is valuable information in each sentence.

The **nextGeneration** series of chargers is equipped with a completely silent backlit LED screen.

2 General remarks and precautions

- The CE marking which you will find on all **schulze** products indicated that the equipment has been tested to meet the stringent European safety and radiation requirements; this does not mean that you do not have to follow these instructions!
- Please remember that fast-charging batteries can push the batteries to their limit; never operate the chargers unattended. The charger as well as the batteries may get warm; when in use, they should be placed on an appropriately sized, non-heat-conducting and non-combustible surface. By following these rules extensive damage will be avoided in case of a mishap. **This applies in the same way also for the attached batteries.**
- Many modern transmitters are equipped with an internal reverse-voltage protection diode. No "smart" charger can fast-charge these transmitters unless this diode is bypassed (shunted) (see chapter 11 for additional information when charging transmitters). Preferably, you can remove the transmitter's battery and fast-charge it outside the transmitter. If you want to bypass the diode, contact the transmitter manufacturer. In no case should the fast-charge current for a transmitter pack exceed 1.2 Amp.
- In order to keep possible damages small in the case of an error, we recommend strongly to remove the batteries from the transmitter!
- Do not modify the charger's car battery power cables or the enclosed connecting clamps; they are very low loss to support the charger's high-end charge capabilities. Do NOT insert fuses and NOT plug the charger into the car's cigarette lighter!



• RISK OF SHORT CIRCUIT! When a balancing cable is plugged into one of the balancing connectors of the charger then the corresponding pins of the remaining two connectors are also carrying voltage. Therefore it is neither allowed to short pins nor connect a second pack to them!

- Do not cross-connect individual output charge cables. Do not short circuit output 1 to output 2. Each charger outlet has its own sensing circuitry - but no cross-sensing. Prevent electrical contact between any charger outlet and your car's body. All this may damage your charger and/or your batteries! It is safest to place the charger on the ground. Place the charger on a safe support, do not "hang" it somewhere under the hood. The best approach is to use a separate, fully charged, dedicated 12-V battery and take it to the flight line.
- The internal software is always checking for operational errors. Do not operate the charger in the case that any of the cables are damaged or frayed, or in case the display panel indicates an ERROR.
- The **nextGeneration** charging devices operates on a wide range of input voltage but may also be connected directly to a 12 V car battery! **DO NOT RUN YOUR ENGINE OR ATTEMPT TO CHARGE YOUR CAR BATTERY WITH EXTERNAL EQUIPMENT WHILE OPERATING THE CHARGER, OR AS LONG AS THE CHARGER IS HOOKED UP TO YOUR CAR'S BATTERY.**
- Should you decide to operate the charger from a (110V/240V AC to 12V or 13.8V DC) power supply*, then make sure this power supply is well regulated, can supply continuous DC current as high as 16 or 25 Amps**, has a very high output capacitance (>5000µF/16V), very low ripple and is insensitive to the frequency of the charger's internal switching voltage converter. Using any other source is likely to damage your charger or your batteries, and voids the warranty. ALWAYS use a **schulze nt-16A** or **nt-25A** power supply**, NEVER use an automotive battery charger as the source for the precision-engineered **schulze** charger.
(*) Variable power supplies must be adjusted to max. 13.8 volts! (**) depends on the charger type.
- **When a nextGeneration is connected to a dc-generator and/or more than one nextGeneration is powered by a single mains power supply then the power supply must be buffered (stabilized) by a buffer battery to avoid interaction between the charger(s) and the power supply.**
- Because of the high charge current capabilities of these chargers, you should always use high-quality, gold-plated connectors in the charge cables to your batteries. Also, use heavy-duty (12-g) flex wire. We recommend you use either **schulze** short circuit protected charging cables and/or (in the USA) 4 mm bullet connectors, the Deans Ultra plug or similar. See your local hobby dealer.
- Always connect the banana plugs of your charge cables first; then, connect the charge cable to the battery. Note that "open" banana plugs, when the charge cable and battery are connected, carry the full battery voltage (and current).
- Note that all chargers have ventilation holes. Especially in discharge mode or when charging batteries less than 12V, the charger will dissipate energy, and thus get warm (the **nextGeneration** even has an internal cooling fan). Do not block these ventilation holes and make sure you allow free air flow.

- Protect the charger from direct exposure to the sun (the sun's heat may temporarily turn the LC-display black), dust, moisture and rain(!).

Even though the **schulze** chargers are smart (they are micro-processor equipped and can determine a battery's number of cells and its optimum charge current pattern), attempting to charge the following packs should not be attempted:

- batteries built up from cells of different types and capacities
- batteries made from different types of single cells
- batteries with a different charging level of the cells
- non rechargeable cells (dry cells)
- batteries which are not expressly designed for fast charging and recharging.
- defective or damaged packs or cells
- already fully charged and/or hot batteries
- battery packs with internal charge-current limiting devices (not valid for Schulze LiPoTx und LiPoRx)
- batteries which are build-in (internal) to other equipment

Do not exceed a battery's design (maximum) charge current as specified by its manufacturer; note that the **schulze** chargers will still optimally charge these packs in automatic charging mode; you can program the charger's max (limit) charge current.

- Please bear in mind that new rechargeable batteries do not achieve their full capacity until they have completed several charge / discharge cycles. New batteries generally, and deep-discharged Nickel batteries in particular, may cause premature charge termination. For this reason it is absolutely essential to check that the automatic charge cut-off circuit works correctly and reliably; this is achieved by carrying out several test-charges, and checking the quantity of capacity charged into the pack.

When charging battery packs with less than 4 nickel cells, exercise extra care to make sure that these are not over-charged (especially when you use less than the specified current for this battery type - see chapter 4). Packs which are (too) deeply discharged may cause the charger to cut off too soon.

New batteries will only achieve their maximum capacity after several charge/discharge cycles; **schulze** chargers can be programmed to provide these cycles automatically.

Please remember that battery packs can heat up considerably especially during multiple charge/discharge cycles; program your charger's max discharge current to prevent overheating of the packs unless you provide additional cooling (some of the racing pilots now use a tube with electric fan cooling!). Note that e.g. discharging a 27-cell 1000mAh battery at 5A (=5C rate) will dangerously overheat this battery; the **schulze** charger can (and) should in this case be programmed to the limit discharge rate to a more acceptable level, for instance 1A (=1C) and/or a battery cooler in combination with the temperature sensor for cut-off must be used. You can also use our build in low-temperature-start circuit. (Do not forget to activate temperature sensor to the right pack output and fix it at the right battery.)

- **Safety hint:** Always verify the charge amount which your battery has absorbed (mAh or Ah) after a full charge (this is indicated on the display panel); this is probably the best gauge of a battery's health and/or the proper operation of the charger. This way, you will avoid unexpected loss of power and/or control.

An additional important function is the selection of the automatic cut-off circuit. Read the important comments in Chapter 12). Maximum protection against malfunctions of the cut-off automatic is provided by selecting additional cut-off criterias like max. temperature, max. energy input and max. charge time.

For trouble-free operation, please check ...

- ... that the ferrite ring in the charge lead does not fracture. The ring prevents the charge lead acting as an aerial, i.e. radiating the pulsed frequency of the voltage converter and the processor in an unacceptable way. It is absolutely essential if the charger is to operate in the manner required for CE approval.
- ... that the charge leads used for the Battery 1 and 2 outputs are as short as possible. The maximum total cable length - from the sockets to the battery - should be no greater than 20 cm. Twist the wires together to help suppress interference.
- ... that the charge lead for charge output 1 is wound through one of the ferrite CE rings at least four times. These rings are probably familiar to you from long servo extension leads, albeit in a different size. The ring must be located no more than 5 cm from the banana plugs attached to the charger end of the charge lead.

Re chapter 5: Mounting instructions for the CE-ring

Accessories, necessary for charge output 1:

CE-kab-i8
not enclosed

CE-ring
1 x enclosed
for example it is mounted on the charge cable



3 Commonly used Terms

Final charge voltage: the voltage at which the battery's charge limit (capacity limit) is reached. The charge process switches from a high current to a low maintenance rate (trickle charge) at this point. From this point on further high current charging would cause overheating and eventual terminal damage to the pack.

Final discharge voltage: the voltage at which the battery's discharge limit is reached. The chemical composition of the batteries determines the level of this voltage. Below this voltage the battery **enters** the deep discharge zone. Individual cells within the pack may become reverse-polarised in this condition, and this can cause permanent damage.

Memory effect: The real memory effect has been recorded by Nasa, caused by repeated charge / discharge cycles. Nasa has found that full capacity can be regained by overcharging the cells. In modelling applications different effects are responsible for the reduction in cell capacity. The problem can be cured by balancing the cells (see below), and prevented by the measures described in Chapter 4.1.3.

Battery conditioning: a method of regaining full (nominal) capacity by alternately charging and discharging the pack, sometimes several times. This process is especially useful after a long period of non-usage (e.g. after purchase, or after several weeks without flying), and is also used to disperse the memory effect (see below). The effect of battery conditioning is to break down the coarse crystalline structure (low capacity) inside the cell and convert it into a fine crystalline one (high capacity).

Power-On (- reset): the status of the **nextGeneration** after it has been connected to the car battery.

Ready message: charger ready to run the program you have just selected (batteries not connected). The display shows "ready".

C: Coulomb or capacity: Unit of measurement relating to the quantity of charged energy. In conjunction with charge current data this unit is used to determine the recommended / prescribed charge current of a battery of a given capacity. Example: if the charge or discharge current of a 500 mAh battery is 50 mA, we refer to this as a charge or discharge at one tenth C (C/10 or 1/10 C).

A, mA: unit of measurement relating to charge or dis-charge current. 1000 mA = 1 A (A=Ampere, mA=Milliampere)

Ah, mAh: unit of measurement for the capacity of a battery (Amperes x time unit; h = hour). If a pack is charged for one hour at a current of 2 A, it has been fed 2 Ah of energy. It receives the same quantity of charge (2 Ah) if it is charged for 4 hours at 0.5 A, or 15 minutes (=1/4 h) at 8 A.

4 Useful information about batteries and maintenance

4.1.1 General information

Do not charge below 0°C, optimum is 10...30°C.

A cold cell is not capable of accepting as much current as a warm one. For this reason you must expect differences in charge characteristics if you use fully automatic charge current calculation for your nickel cells (in Winter the charging properties will be worse than in Summer). The best **working temperature for a Ni-MH cell is 40 ... 60°C**. At lower temperatures the cell can not supply higher currents. Caution when using those cells at a receiver battery in a helicopter in the wintertime.

The lower the internal resistance of the battery, the higher the charger can increase the charge current for that battery. **For a battery charger which sets the current automatically the resistance of the cable is added to the internal resistance. For this reason: use heavy duty wire (large cross-section), even for receiver batteries, and keep them short. Do not charge via a switch or switch harness!**

If you wish to measure battery capacity accurately a suitable discharge current is usually 1/10 C.

4.1.2 Reflex charging

Charging processes which include a brief discharge pulse definitely have the effect that the battery is several degrees cooler at the end of the process. However, from the point of view of the competition operator this is an undesirable effect, as the cell chemistry can only supply high currents if its temperature is raised to a certain extent.

All these effects, whether they actually occur or are simply hear-say, have no practical significance if batteries are correctly handled in the first place. When a battery is full, you can't fill it any fuller! Read also chapter 4.1.3 for this subject area.

4.1.3 Memory effect of Ni-Cd & Ni-MH cells

If cells are repeatedly stored partially discharged, or are recharged from a half-discharged state, what is known as the memory effect sets in. The cells note that their full capacity is not required, and react by refusing to make it available.

One aspect of this is that the crystalline chemical structure inside the cell changes; the cell's resistance rises and its voltage collapses under load, with the result that "full capacity" can no longer be exploited at normal discharge currents.

Even if reflex charging were to eliminate the memory effect, there is no denying the necessity to store your cells in the discharged state; this applies to Ni-Cd cells and also to Ni-MH cells.

A characteristic fact of these cells is that they self-discharge - and the rate of self-discharge is different for each individual cell in a battery pack! If a fully charged pack is left for a considerable time, it will eventually consist of cells of widely varying states of charge.

If at this point you ...

- a) ... **give the pack a full charge:** the cell with the highest charge will be overcharged, heat up and be ruined, while the cell with the least charge will still not be full after the same period of charging.
- b) ... **discharge the pack:** the cell with the least charge will be completely flat first, then reverse polarity and often suffer an internal short-circuit. At the point when this happens, the cell with the most charge is still not yet completely discharged.

This is a reliable method of wrecking your most valuable packs - and rest assured that reflex charging will make absolutely no difference. However, there is one method of avoiding the problem: discharge cells after use, and recharge them just before use!

4.2 Nickel-Cadmium-batteries (Ni-Cd)

Nominal voltage level: 1.2 V / cells.

Selecting the fast charge current (manual setting):

Charge current = 2 C (never less!) (C=nominal battery capacity). Otherwise the cells do not make a detectable peak and the peak cut off automatic is not able to work resp. to work reliable.

Maximum continuous discharge current:

Currents of 10 C to 30 C are possible, depending on cell type.

Long time storage:

Empty i.e. discharged to the discharge voltage cut off level, at low temperature (-20°C to +10°C).

Maintenance: Charging: The automatic current setting circuitry (patent applied for) provides optimum protection to your Ni-Cd batteries during charging. The reduced current towards the end of the charge ensures a completely full pack combined with only a slight temperature rise, as you will easily see in comparison with conventional constant current techniques.

Do not use the automatic charge current calculation of the Ni-Cd batteries when charging Ni-MH batteries!

Discharging: To prevent your cells from memory effect and to keep the full capacity you have to discharge it after use, even when you store it over night (select Auto-D program to discharge down to 0.85V / cell).

If a battery is brand-new or used irregularly it is often only possible to condition it completely by carrying out several discharge - charge cycles. Amongst model car operators it is standard practice to erase any memory effect by completely discharging each cell individually via a resistor (approx. 68 Ohm). This deliberately "un-forms" the pack, but it can cause the automatic charge termination circuitry to switch off the current prematurely during the charge process. Remedy: Discharge with a 10 Ohm resistor in series to a 1 A diode (1N4001).

For receiver batteries special types such as the Sanyo KR500AAEC / N500AC (high reliable) are a good choice.

Warning: If using reduced charge current with 1-6 cells makes the voltage peak in the charge curve very slight, especially with batteries of high nominal capacity. In this situation the charger is sometimes unable to detect the "full" condition due to the ill-defined peak.

4.3 Nickel-Metal-Hydride batteries (NiMH)

Voltage level: 1.2 V / cell.

Selecting the fast charge current manually (not automatically):

Charge current typical 1 C (never less!) (set a fixed current of, for example, 1.2 A with 1100 mAh batteries, or 3 A with 3 Ah cells). Otherwise the cells do not make a detectable peak and the peak cut off automatic can not work reliable. Some modern high-current Ni-MH cells made by particular manufacturers can safely be charged at a higher rate of up to 1.6 C (Panasonic 3000: 3,5 - 4A, GP 3000/3300: 3 A, Saft 3000: 3 A (not if battery is charged inside a transmitter!), Sanyo 3000/3300: 4 - 5A). Because of its high internal resistance do not charge high capacity cells of mignon(AA)-size from 1500 mAh upward with automatic current calculation (AutoC, -CD, -DC).

Maximum continuous discharge current:

Currents of 5 C to 15 C are possible, depending on cell type.

Long time storage:

Store old generation cells empty, (those types which had been available in the SUB-C size up to 3.3 Ah) i.e. discharged to the cut off level (see maintenance), at low temperature (-20°C to +10°C).

The **new generation cells should NOT be stored empty** - The self discharge rate is too high!

Discharge down to the cut off level (see maintenance) and then **charge in about 30%** of their capacity (use the quantity cut off feature). Store all cells at low temperature (-20°C to +10°C).

Maintenance: To protect your Ni-MH batteries from the memory effect and keep the full capacity, discharge the cells after use down to the discharge voltage limit even when you store it over night and add 30% (new cell types). Never discharge by car bulbs or the drive motor (premature charge termination!), but use only the **Auto-D** programm when the battery type **Ni-MH** is selected. The cut off voltage is 1 volt / cell. This eliminates the danger of deep discharge termination and polarity reversal (over-discharge).

It is important that you take the trouble to give **Ni-MH** cells when storing at **+10...30°C** a charge / discharge cycle around every four weeks, otherwise they become tired, and have to be pampered.

to restore them to full vigour. This involves going through the tiresome business of many repeated charge / discharge cycles.

The automatic current setting circuitry (patented) provides optimum protection to your Ni-MH batteries during charging. Please use the Ni-MH automatic current calculation always with a **correctly adjusted** charge quantity monitoring circuit (see chapter 14.2.6). Do not use the Ni-Cd automatic current selection for Ni-MH batteries!

Warning: Never charge fully charged Ni-MH batteries with the Auto C (or ..CD programs): Overheating and danger of explosion! The cut off automatic is disabled for about the first 7 minutes of charging - this could lead to a minimum charge time of about 10 minutes!

Warning: At lower cell counts (1-6) and low charge currents (below 1 C) the battery makes only a very low voltage peak when fully charged. Under those conditions the cut off automatic works less reliable than with higher currents and/or higher number of cells.

Hint: The optimum operating temperature of Ni-MH batteries is 40-60°C!

Typical for Sanyo Twicell industry types with flat top and RC3600HV cells:

High maximum load capacity and voltage level.

Typical for Panasonic P3000NIMH cells:

High maximum charge capacity and voltage level, load current up to 40 amps.

Typical for GP 3300 cells:

Extremely high charge capacity, good voltage level.

Can be discharged with medium currents (about 40...45 amps; from year 2003 up to 60 amps).

Typical for GP 3700 / GP4300 / IB4200 cells:

Very high voltage level. Very high self discharge current. Up to 60 amps load current.

4.4 Lead-acid batteries (Pb) ...

... and VRLA (valve regulated lead-acid batteries = lead-gel batteries)

Nominal voltage level: 2.0 V / cell.

Charge voltage level: 2.3 V / cell; 2.42 V / cell for 3 hours max.

Min. discharge voltage: 1.7 V / cell (this reduces lifetime).

Number of cells to be selected on the **nextGeneration:**

Nominal voltage of the battery to be charged divided by the nominal voltage level of lead-acid battery cells = cell count. Example: 12 V-Lead acid battery divided by 2,0 V => 6 cells.

Selecting the fast charge current:

Charge current = 0.15 C (C = nominal battery capacity) if no data sheets are available.

Charge current up to 0.4 C for special types.

Maximum continuous discharge current:

Typically 0.2 C, short time load up to 1 C.

Long time storage:

Full at low temperature, more precise:

At +10°C up to 12 month, at +10...20° max. 9 month, at +20...30°C max 6 month, at +30...40°C 3 month.

Charge again after this period.

Maintenance: In contrast to Ni-Cd/Ni-MH batteries, lead-acid batteries must be fully recharged after use in order to maintain full capacity.

The nominal capacity can be reduced very quickly by incorrect handling (overloading, repeated 100% discharges, and especially by deep-discharges). Please observe the battery manufacturer's recommendations.

Typical: The characteristics of lead-acid batteries are quite different to those of the Ni-Cd sealed cell packs which are used as the power source in model aircraft, cars and hydro-boats. They can only tolerate relatively low currents relative to their capacity if their full capacity is to be exploited, and/or the voltage is not to collapse too far.

Used as single-cell glowplug energiser batteries and power source in some scale boats.

Low self-discharge rate.

4.5 Lithium-Iron-Phosphate batteries (Li-FePO4)

Nominal voltage: 3,2 V / cell.

Max. charge voltage: 3,65 V / cell.

Min. discharge voltage: 2,0 V / cell.

Selecting the fast charge current: Up to 2 C.

Maximum contin. discharge current: Up to 15 C.

Long time storage: The manufacturer recommends that 30% to 50% state of charge at 23 °C is best for a maximum time of 6 month. It offers a compromise between impedance creep and storage safety.

Then discharge and charge to 50% capacity (use "quantity cutoff").

Typical: These cells are even recommended as receiver batteries (2 cells have about the same voltage as 5 fully charged Nickel-cells), but also recommended for feeding a motor.

Hint: The most common form of this battery type is the „Saphion“ or the "A123" cell.

4.6 Lithium-Ion batteries (Li-Io & Li-Po)

Nominal voltage Lilo: 3,6 V / cell (SAFT)

Nominal voltage Lilo/LiPo: 3,7 V / cell (SANYO, KOKAM)

Max. charge voltage **Lilo:** 4,1 V +-40mV / cell (SAFT)

(absolute limit 4.3 V / cell)

LiPo: 4,2 V +-50mV / cell (MoliCel)

Min. discharge voltage **Lilo:** 2,5 V / cell (MoliCel), 2,7 V / cell (SANYO)

(absolute limit 2.3 V / cell)

LiPo: 3,0 V / cell (KOKAM)

Number of cells to be selected on the charger:

Nominal voltage of LiPo-pack div.by nominal cell-voltage = cell count.

--> 11,1 V LiPo-pack divided by 3.7 V => select 3 cells!

If you would select more cells, the pack would explode during charging!

Example: The Thunderpower TP8200 3s4p pack consists of 12 cells.

4 of 2050mAh are connected parallel (4p) -> 4 * 2,05 Ah = 8200mAh.

3 of the paralleled cells are connected in series (3s)-> 3*3,7V= 11,1 V.

Selecting the fitting cell type:

Select that battery type from the **nextGeneration** menu which characteristics match best with the data sheet of the battery manufacturer.

Selecting the fast charge current:

Charge current = 1 C (SANYO / KOKAM) or less (0,7 C PANASONIC) (C = nominal battery capacity).

Maximum continuous discharge current:

1 ... 20 C (very new types), depending on cell type.

Long time storage:

Empty, i.e. discharged to the discharge voltage cut off level (see maintenance), at low temperature (-20°C bis +10°C) or at ambient temperature as described in **chapter 12.3**.

Maintenance: Discharge with up to 1 C down to above listed discharge voltages. Always store these cells in the discharged state, if stored fully charged, the result can be a permanent reduction in capacity.

When stored at +40°C or more charge additional every two months.

Typical: Very good weight : energy ratio. High load cells have also a good weight : power resp. performance ratio.

Hint: Many manufacturers direct how many cells are allowed to use in series and/or parallel use.

The exact technical term of a **Li-Po** cell is Lithium-Ion-Polymer battery. These are hybrid cells and contain gelled electrolyte to enhance ion conductivity. The "true" (dry) Lithium-Polymer cells suffers from poor conductivity and work only with higher temperatures of more than 60°C.

5 Mounting instructions CE ring

Use 2.5 mm² cables, 1 cable red, 1 cable black.
 Solder 1 male socket at every end of cable.
 Slide ring from free end of cables to 4 cm (2") to the male sockets and fix it with your fingers. Make additional 3 windings through the **center** of the ring.
 Cut cables to 15 cm, if cables at the pack have 5 cm (Max. total length 20 cm).
 The cables now looks like those of the picture on page 4.
 Bind cables with short pieces of heat shrink tubes.
 Solder your connectors on to the free ends of the cables now.
 You can also use our pre-fabricated charge cables CE-kab-i8.

--> See mounting photo on page 6

6 Functions

Please read section 7 "The first step" first that you know how to select all the charge and discharge programs listed below.

Charge- and discharge programs of battery output 1 are split into groups, which can be selected using the +/- buttons in the belonging **prog.** menu.

The charger will perform the option you select by pressing the **enter** button.

All programs use those currents as their maximum, which were separately selected under **cCurr** and **dCurr** in the parameter screens of both outputs.

2 fixed current combination programs*	fix_CD, fix_DC,	(up to 5 cycles)
2 automatic current calculation combin.programs*	auto_CD, auto_DC,	(up to 5 cycles)
1 fixed current charge programm	fix_C,	
1 fixed current discharge programm*	fix_D,	
1 automatic current calculation charge program	autoC,	
1 automatic current calculation discharge program*	autoD.	
	[*] only at battery 1 output	

Currents (tabular) [Amps] 0.1, 0.15, 0.2, 0.25, 0.3, 0.5, 0.4, 0.6, 0.8, 1.0, 1.2, 1.5, 2.0, 2.5, 3.0, 3.5, 4.0, 4.5, 5.0, 5.5, 6.0 <c>, 6.5, 7 <d>, 8, 10 <e>

 3.0 amps is max for battery 2 (next 10.36-XX: 5.0 A)

<c,d,e> different maximum current on output 1 (depends on the type of charger).

The actual charge current may also vary with battery type, number of cells, battery condition etc.

Especially for the users of brushed motors the nextGeneration offers a special run-in program, which can be selected in the battery type menu. („bType:RunIn“).

Many parameters for an optimum run-in procedure can be selected in this menu: The maximum motor current, the maximum run-in voltage, the maximum run-in time, the maximum motor temperature and the maximum „charge“-quantity which is available when a battery of a determined capacity would be used for the run-in procedure.

7.1 The first step - the screens

7.1 Take the nextGeneration out of the packaging.

See Chapter 2: General Remarks and Precautions. Lack of air circulation may cause overheating.

7.1.1 Connect the nextGeneration to the 12 volt power source car battery.

Note: No battery packs must be connected to the charger during this procedure. Try to achieve a good contact to the car battery terminals first time, otherwise you may not get the **power-On** screen on the display. In this case disconnect the charger **immediately** from the car battery and retry after about 5 seconds.

7.1.2 Initially the liquid crystal screen very briefly shows the software version of the display processor; the screen backlighting is then switched on and displays the PowerOn menu screen along with the type designation "nextGeneration x.yy-z" (exact type designation), the ms logo, the software version and the owner's name. At this point you can also switch to the second menu language, if you wish; simply follow the on-screen instructions (see chapter / figure 23.2).

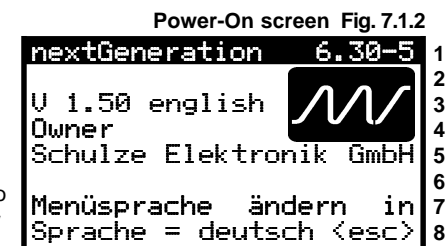

If YOUR language is not available on the charger please check if it is available on our homepage or our USB-stick (in preparation) and install it on your charger. Follow the help text of the installation program.

7.2 The nextGeneration features **nine operating buttons**, arranged in three groups. The **three buttons <1>, <par> and <2>**, which constitute the Parameter button group, are used to move to the battery and device parameter screens.

7.2.1 Selecting <1> or <2> initially brings up the graphic screens which display the charge / discharge voltage curves and the most important set parameters; these are shown in the first two lines of the screen (picture right).

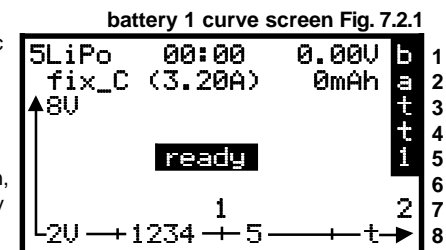

7.2.1.1 If the curve screen for Battery 1 is on the screen, you can switch directly to the curve screen for Battery 2 (and vice versa) by pressing <2>.

7.2.1.2 If one of the two curve screens is displayed

(Battery 1 or Battery 2) you can press <info> (= <enter>) to access status displays for these batteries which are not included in the curve screen (Chapter 1.4). Pressing the <info> button again calls up information about the state of the power supply (e.g. the car battery) (Chapter 1.5).

7.3.1 For example, if the curve screen for Battery 1 is displayed (Fig. 2.1), then another press on <1>

switches to the parameter settings for Battery 1 (and vice versa). The information for all parameters is shown on a single screen, and is therefore slightly compressed, but this is in response to requests from many users that all the parameters should be visible without having to switch between screen displays. When a combi-program is in use, the circle shows the number of cycles.

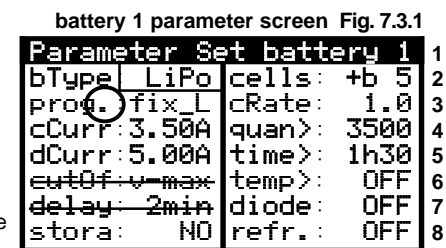

Remark: You also can select an option in the device parameter set 1 with "wide" screens (chapter 23.14).

Setting the „cRate“: By the definition of the Schulze-balancing cables the charge current depends on the current resistor soldered in. If you wish to use a higher (or lower) charge current than that defined by the configuration of the lead, you can "turn this parameter up or down".

7.3.2 For example, if the parameter screen for Battery 1 is displayed, pressing <2> switches directly to the parameter screen for Battery 2.

Fig. 7.3.2 Parameter-screen Battery 2

```

1 Parameter Set battery 2
2 bType NiMH cells: 0
3 prog.: autoC eRate: -
4 cCurr: 3.00A quan>: 4000
5 - : - time>: 1h30
6 cutOf: sens. temp>: OFF
7 delay: 7min diode: NO
8 - : - - : -
    
```

7.3.2.1 The parameter set for Battery 2 is not identical to the parameter set for Battery 1; for example, it is not possible to set a discharge current, as the hardware for a discharge stage is not present for that output.

The maximum charge current for Battery 2 is also much lower than that for Battery 1.

In Figs. 7.3.1 and 7.3.2 you will see a rectangular box (known as the cursor box) around the battery type "LiPo" and "NiMH". This indicates that pressing <enter> at this point would take you to the set-up menu for that battery type.

7.3.3 The second button group (of four buttons, i.e. the <+> and <-> buttons and also the <I> and "r" buttons) is used to move the cursor box to any of the parameters which can be changed (!).

If parameter values are not present (e.g. discharge current for Battery 2), or if a particular parameter cannot be changed during the charge phase (e.g. the charge current when the battery is almost full - in order to avoid upsetting the peak cut-off circuit - or the number of cells when using a Lithium program), then the cursor box cannot be moved to these positions. Such positions are marked with a minus sign, or are shown temporarily crossed out.

7.4 Move the cursor box back to the position shown in Fig. 7.3.2 next to "Bat type", and press <enter> .

Fig. 7.4.1 Battery type selection battery 2

```

1 Param. Selection batt 2
2 select battery type
3 +-----+
4 | Lead | + change
5 --> Ni-MH <-- value
6 | Ni-Cd | - change
7 +-----+
8 to abort press <esc>
    
```

7.4.1 This action opens the menu screen shown in Fig. 7.4.1, whose first line (title) reflects the menu by displaying "Parameter selection - battery 1".

Line 2 shows in a plainer, less "cryptic" form which parameter value you can change, as in the previous parameter set menu (Fig. 3.1 or 3.2); in this case: "battery type selection".

7.4.2 You can move the various battery types up and down in a small window using the <+> and <-> buttons. Line 5 of the small window shows the value to be

selected, and in each case the adjacent table value: line 6 (below it) shows the preceding value, line 4 (above it) the subsequent value. The end (and the start) of the table is marked by horizontal lines (minus signs).

7.4.3 Once you have set the appropriate battery type, press the <enter> button to conclude the Selection menu.

7.4.4 If you moved to the battery type selection menu by mistake, you can leave it without changing anything by pressing <escape> (interrupt, button group 3), even if you have changed the battery type in the meantime using the <+> and <-> buttons.

7.4.5 Notes: choosing a new battery type automatically activates the parameters which were set last time you used the same battery type.

For this reason, if you wish to switch battery type you should always start by selecting the battery type itself, rather than perhaps by changing the charge current or the charge program, as changing the battery type would in any case overwrite your earlier changes.

When leafing through the battery type selection menu you will notice that additional menu points in the form of "write" and "read" are present in addition to the battery types. These entries refer to configurations which you can store and subsequently call up (see Chapter 24).

All the other parameter menus (e.g. charge current, charge quantity limit) are navigated and used in the same manner.

7.5 The parameter button group 1 includes a button marked <par>.

7.5.1 Pressing the <par> button once calls up the parameter screen 7.5.1, which contains the device settings described below.

For example, this menu segment includes settings which define how you wish the charger to behave when a battery is fully charged.

At this point you can also restrict the charger's power consumption, so as to avoid overloading mains PSUs of limited capacity when charging a battery. Not least of these menu functions is the ability to enter your name.

The meaning of all the parameters is described in Chapter 23.

7.5.2 Pressing the <par> button a second time calls up the parameter screen 7.5.2, which primarily contains set-up parameters for Lithium batteries (upper and lower voltage limit values). The charger's funnel-shaped balancing function is already familiar from the other Schulze balancers.

Note: the asterisks "*" which precede the set-up values in the right-hand columns of Figs. 7.5.1 and 7.6.1 mean that the user has set the recommended parameters (suggested values) for the menu point in question.

7.5.3 If you press the <par> button repeatedly, then you always alternate between the two device parameter screens, i.e. Figs. 7.5.1 and 7.5.2.

You can move to the Power-On screen (Fig. 1.2) by pressing the <esc> button, to the battery curve screen (Fig. 7.2.1) by pressing <1>, and to the Battery 2 curve screen by pressing <2>.

7.6 When the screen is displaying a curve rather than one of the parameter displays, then the <enter> button actually has no function. For this reason we have used the <enter> button in this case for displaying screens with additional information content <info> relating to the current charge / discharge process for Battery 1 and Battery 2, or the state of the device.

7.6.1 Pressing <info> when one of the two curve screens (Battery 1 or Battery 2) is on the screen causes line 1 to show the charge status for both batteries, the current program for both batteries, the number of cycles for Battery 1 (up to the maximum number of five cycles), the actual charge quantity for Battery 2 (at top right of the screen) and the internal resistance of the two batteries (bottom right of the screen - see also Fig. 7.6.1 on the next page).

Note: the centre column displays the charge quantities with the appropriate prefixes from line 2 (before and after the program).

7.6.2 Pressing <info> two times when one of the two curve screens (Battery 1 or Battery 2) is displayed calls up information about the device and the current "power supply situation" (see also Fig. 7.6.2 on the next page).

7.6.3 Pressing <info> repeatedly toggles between the screens 7.6.1 and 7.6.2 and the curve screen previously displayed.

Pressing the <esc> button takes you to the last curve screen displayed, while the <1> or <2> buttons take you directly to the corresponding curve screens.

Device parameters 1 Fig. 7.5.1

```

Parameter Set 1 nextGen 1
fan [ OFF curr>: * 16A 2
light: blink powr>: 150W 3
buzzr: ON batt<: 11*2U 4
illum: ON temp>: *60°C 5
dQuan: OFF - : - 6
name : >new< passw: >new< 7
Schulze Elektronik GmbH 8
    
```

Device parameters 2 Fig. 7.5.2

```

Parameter Set 2 nextGen 1
value tabul menu: small 2
start: autom setTo: deflt 3
balan: autom carBat: reset 4
uLiPo: *3000 ULiPo: *4200 5
uLiIo: *2700 ULiIo: *4100 6
uLiFe: *2000 ULiFe: *3650 7
- : - - : - 8
    
```

Fig. 7.6.1 State info 1 (battery 1 & 2)

```

1 state:  b1 charg ready
2 progr  +auto2CD-  fix_C
3 cyc11  2400  2348  0
4 cyc12   123    0  RiB1=
5                                     317mΩ
6                                     RiB2=
7                                     0mΩ
8 capac.[mAh] batt1 batt2
    
```

State info 2 (device) Fig. 7.6.2

```

State info  nextGen
DeviceType: next 6.30-5
Software Vers: 1.50
Device Number: 333
Input Voltage: 13.20V
Inp. Curr. Draw: 5.30A
TakenCapacity: 1.61Ah
Schulze Elektronik GmbH
    
```

7.7 The first step - the most important settings

In Chapter 7.1 you have become familiar with the menu screens and how they are navigated and used; for example, which parameters have to be set in order to charge a Nickel battery properly. If you find you have made so many changes that you no longer understand what is going on, then you may need to carry out a general reset to restore the default settings (Fig. 5.2 "setTo:default"). Press the <1> button repeatedly until the curve screen is displayed. The screen shows an empty coordinate system with "minutes" running from left to right, and the voltage axis running upward. The screen name "Battery 1" is shown in inverse video (black background) at the right-hand margin of the screen, with a vertical column of characters.

Before you carry out an initial test by charging the first battery, please examine the upper lines of the screen to check that the status displays match the battery to be charged. Of course, when you operate the unit for the first time many fields will not contain any values, but once you disconnect the battery the old values will be retained for checking purposes until you connect a new pack. In most cases the right choice for Nickel batteries is the fully automatic charge program "autoC". During the charge process the fully automatic programs measure the battery repeatedly to determine its ability to accept current, and they then set the required charge current automatically. In practice this means that you do not need to have exact knowledge of the type of Ni-Cd/Ni-MH sintered cell in use, provided that its capacity lies within the permissible range of 100 mAh to several Ah. The only important point is that Ni-Cd cells must ensure a charge current of 2 C and at Ni-MH's a current of 1 C.

Fig. 7.1 curve screen battery 1

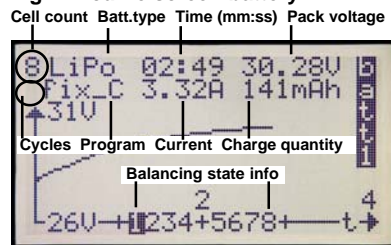

If you charge a Nickel battery and the automatically set charge current remains below 1C (1C = nominal battery capacity), this generally means that the cells are not - or are no longer - capable of being fast-charged (e.g. high-capacity Ni-MH batteries of AA or AAA cell size). If the pack has a low cell-count, these low charge currents will present problems when the automatic cut-off circuit attempts to detect the "battery full" state, as the voltage peak which develops is not sufficiently pronounced. In this case the only recourse is to charge the pack with a manually set current, or - even better - change to a more suitable battery type; assuming, that is, that there is no problem with the charge lead.

The fully automatic programs can only work correctly if the conductors of the charge lead are of adequate cross-section (2.5 mm² - even for charging transmitter and receiver batteries !!) and if the battery cells are soldered (!) together, i.e. they are not simply clamped in a battery box.

7.7.1 If you wish or are obliged to change the parameters relating to Battery 1, press the <1> button again: this calls up a text screen with the title line in inverse video; this is the parameter set-up menu for Battery 1, which should be familiar to you already from Fig. 7.3.1.

If you wish to give your Nickel batteries a full charge combined with maximum safety, the following parameters must be set to sensible values before you start charging the pack.

7.7.2 left - Battery type: e. g.: „bType : NiMH“

7.7.3 le - Program selection: suggested setting for Ni-Cd and NiMH batteries: „prog. : autoC“

7.7.4 le - Charge current: „cCurr:xxxA“. If an automatic program is used (see 7.7.3 left), this parameter should generally be set to the maximum possible charge current, since the automatic circuit continuously varies the current during the charge process. Special hint: Placing a "lid" on the current - especially if it is below 1C for Ni-MH batteries or below 2C for Ni-Cd batteries - may cause the automatic cut-off circuit to fail.

Parameter screen battery 1 Fig. 7.7.x

```

1 le Parameter Set battery 1 1 ri
2 le bType NiMH cells: 0 2 ri
3 le prog. : autoC eRate: 3 ri
4 le cCurr: 3.50A quan>: 500 4 ri
5 le dCurr: 5.00A time>: 2h30 5 ri
6 le cutOf: sens. temp>: OFF 6 ri
7 le delay: 7min diode: NO 7 ri
8 le stera: NO refr.: OFF 8 ri
    
```

7.7.5 le - Discharge current: We recommend „eStrm = max. device current“ for the autoD selection.

7.7.6 le - Automatic cut-off: Method of working of the automatic cut-off circuit. The setting which works with most batteries is: "cutOf: norm." for Ni-Cd batteries or "cutOf: sens." (sensitive) for Ni-MH batteries.

7.7.7 le - Delayed response of the cut-off circuit: Deep-discharged batteries tend to cause a premature cut-off in the first few minutes of a charge process. This menu point prevents the charger checking for "battery full" for several minutes, but please note that it can lead to overheating if a fully charged battery is connected. „delay : 7min“ is fixed at Ni-MH batteries and "autoC".

7.7.2 right - Cell count: With a Nickel battery the cell count remains at zero, as no battery is connected to the charger. The charger automatically corrects the cell count during the charge or discharge process - repeatedly if necessary. Note: It is certainly possible to correct the cell count manually while a charge or discharge program is in progress, but the cell counts calculated by the unit are generally accurate enough, and are not used when charging Nickel cells in any case.

7.7.3 ri - Setting the C-Rate: By the definition of the Schulze-balancing cables for Lithium batteries the charge current depends on the current resistor soldered in. If you wish to use a higher (or lower) charge current than that defined by the configuration of the lead, you can "turn this parameter up or down". Normally the current multiplication factor is set to 1.0: „cRate: 1.0“.

7.7.4 ri - Charge quantity limitation: An important factor in terms of safety is the maximum charge quantity (battery capacity). You need to estimate how much energy can be charged into your battery. A normal, completely discharged Ni-Cd 2400 mAh cell can generally accept 2400 - 2600 mAh. This means: The maximum charge quantity for flat 2400 cells "quan> 2700" mAh. For Ni-MH cells the basic rule is to set the battery capacity in mAh, plus an addition of about 30%, since the charge quantity limit has a dual function (see Chapter xx).

7.7.5 ri - Charge time limitation: The next safety function is to enter the maximum charge time. The charge time for a fully automatic charge program can only be estimated, as the actual period varies according to the specific cell type. If you do not already know this figure from personal experience, we suggest that you enter a figure at the higher end of the range: Time> 30...45min (for Ni-Cd cells).

Please note: If the charge time exceeds three hours, then something is fundamentally wrong: either the battery is defective or of high internal resistance (e.g. many AA and AAA cells), the charge leads are too thin, or the connectors are not up to the job.

7.7.6 ri - Over temperature cut-off: The temperature cut-off should be left at OFF: "temp>: OFF" (in particular if the nextConn circuit board is not installed. See Chapter 14 for more details).

7.7.7 ri - Discharge protection diode: This is only required for transmitters fitted with an integral protective discharge diode; the ideal choice is therefore normally: "diode: OFF". If lithium- or lead-batteries with built-in diode are charged, then the batteries are not full despite the „full“ display. The reason is that the nextGeneration is not able to detect the diode.

7.7.8 ri - Refresh charge: Refresh charge: this should be switched on if you wish to subject your battery to brief discharge pulses during the charging process (only possible at the Battery 1 output). It is claimed that tired batteries can be revived more quickly using this method, and it is likely that the principle could be relatively successful with transmitter and receiver batteries, which are almost never discharged completely. However, since the process does not compensate for differences in self-discharge rates between the individual cells of the pack, and since it does not increase the capacity of the cells, this function is purely a matter of taste ... refresh charging is switched off in any case when charging Lithium batteries with the Balancer active, as it could have adverse effects.

- 7.8** The **nextGeneration** starts the charge / discharge process according to the configuration in Fig. 5.2: "**Start:**" automatically when the battery is connected, or manually by pressing the "+" button.
- 7.9** The **nextGeneration** switches the current off when the charge process is complete, and displays a FULL message (or EMPTY, or - if the cut-off failed - TEMP or TIME), and beeps for about thirty seconds.
- 7.10** At the start of a fixed-current charge program you will hear a single brief beep when you connect the battery; the charger emits two beeps if an automatic charge program is in use, and one long beep for a discharge program.

You should now know the most important functions. Still, we strongly recommend you to study the rest of the manual to make the best use of your device and learn about further options and how to interpret warnings and errors.

8 Nickel battery programs (Ni-Cd, Ni-MH)

After being disconnected from the car battery, the **nextGeneration** will turn back to the last program.

If a different program is required, it has to be selected **before connecting a pack**.

After termination of the chosen program - the pack is now full or empty - a buzzer or a melody will play for a short time period and the blinking light output becomes permanently activated. To interrupt just press the +/- key. The LCD panel shows the final values.

As the screen only shows the graph for one battery you may want to know what is happening on the other Outputs. Press: „**info**“ from the appropriate screen and the display will provide the status of all connected batteries. Even screen updates will take place in this mode.

Program- and Parameter selection:

Whenever a nickel-program with our patented automatic current calculation is selected, "**auto**" or "**aut**" will appear in the display. Lead- or Lithium programs are only fixed current programs.

Note: Program select is closely linked with the menu items "**dCurr**" and "**cCurr**".

Please read the following paragraphs.

Ensure the cut-off mode and safety functions selected will suit your battery.

If the safety functions have been set up incorrectly, they may not only lose their intended purpose (avoiding overcharge in case of a malfunction), but may even cause adverse results, i. e.:

Interrupting the charge before the battery is full.

Data like charge time, voltage at end of charge and charged capacity may give valuable information about the charge behaviour, the capacity of the connected battery-pack or improper full indications.

Note:

Because of the way the automatic current calculation programs work, they are **not suitable for charging Nickel-transmitter batteries**, nor for charging batteries fitted with thin (standard) charge leads. When the charge current is calculated automatically, the circuit takes into account the conductor tracks in the transmitter, the thin charge leads (e.g. to the receiver battery) and the connectors (usually with a maximum current capacity of only 1 A), and this leads to extremely low charge currents which cause the automatic charge termination circuit to fail.

Typical result: the transmitter battery is overcharged, and may leak or explode!

For this reason: never charge a transmitter battery in the transmitter.

However, if you insist on doing this (on your own head be it): always select a fixed current program.

But please note: NiCd batteries have to be charged at 2 C and NiMH batteries at 1 C, so a 3000 mAh Ni-MH transmitter battery should be charged at a current of 3 A. No transmitter's circuit board tracks will tolerate such currents, and neither will the connectors used for the transmitter and receiver batteries (generally these are only approved for 1 A).

We do not recommend this method of battery charging, and expressly deny any liability if you decide to use it!

8.1 Ni-Cd/Ni-MH charge program with **manual** charge current selection (**fixC**)

These programs will charge your batteries with your selected **cCurr** directly after connecting your batteries.

Partly suitable to charge transmitter batteries (see hint on the page ahead).

Please note that the microprocessor may reduce the current if due to the chosen charge rate the rising voltage or current threatens to cause overheating.

The **nextGeneration** charges until full condition is detected. The charger switches to trickle charge ("t", Ni-Cd batteries only). Charge time, battery peak voltage and loaded capacity are displayed on the screen. Full indication also starts buzzer for a short time.

Suitable charge currents may be selected by the following rule:

Charge current = 2 x C (C=nominal cell capacity)

Example: Cell capacity C = 1.2 Ah, charge current 2 x 1.2 = 2.4A. Selected charge current: 2.5A

8.2 Ni-Cd/Ni-MH charge program with **automatic** charge current selection (**autoC**)

These programs will charge your batteries with your selected **cCurr** directly after connecting your batteries. The charger automatically calculates a charge rate which suits the battery. The battery will continuously be checked during the charge and the charge current is adapted to the actual condition. Initially the program starts with 300 mA, then increases the current to the calculated values, which may result in a reduced current towards the end of the charge.

Partly suitable to charge transmitter batteries (see hint on the page ahead).

The program will not exceed the maximum value set in menu item **cCurr**.

Caution: the automatic NiMH circuit works with a high initial current which should not be limited without due reason

The **nextGeneration** charges until full condition is detected. The charger switches to trickle charge ("t", Ni-Cd batteries only). Charge time, battery peak voltage and loaded capacity are displayed on the screen. Full indication also starts buzzer for a short time.

Note: In contrast to other programs, this fully automatic program always starts with a double beep when you connect the battery.

8.3 Ni-Cd/Ni-MH discharge program with **manual** current selection (**fix D**)

This program starts with the **dCurr** current you have previously chosen, when connecting the batteries to the battery 1 output, and ends when the discharge voltage is reached. During the whole discharge the current will be kept at the value you selected, or may be reduced in order not to exceed the performance range of the **nextGeneration** which depends on the cell count, the car batteries charge level and/or the temperature of the electronic load.

In contrast to the Capacity Measuring program, the discharge programs enable you to determine the remaining capacity of a partially discharged battery (for example to measure how much is left in your Rx battery after a couple of flights).

At the end of the program discharge time, discharge voltage and discharged capacity will be displayed. A buzz or a melody will be activated for a short time.

Note: For precise measuring of battery capacities a discharge current of 1/10 C is recommended, i.e.: a 1000 mAh battery should be discharged with 100 mA.

For practical purposes higher discharge rates can be tolerated and may even be more realistic.

In other cases you should limit the maximum discharge current in the menu point dCurr for cells of low capacity (e. g. receiver batteries) which could be grow too hot subjected to excessive discharge currents; this avoids the cells being damaged through this overheating. Recommended values for maximum continuous currents are 1 C to maximum 2 C.

Info: The discharge cut-off voltage used for the Ni-Cd-discharge programs is about 0.85V per cell, for Ni-MH batteries the level is about 1 V/cell. The microprocessor will detect the number of cells with sufficient accuracy.

When deep-discharged cells are connected, the number of cells will automatically be corrected after about 1-10 minutes.

Manual corrections may be made via menu item **cells**, while the program is running.

8.4 Ni-Cd/Ni-MH discharge program with **automatic** current selection (autoD)

This program starts discharging after the battery is connected. The battery is initially discharged for around a minute at a low discharge current while the charger measures its characteristics. It then applies a discharge current suitable for the battery.

The discharge current will not exceed any discharge value programmed under **dCurr**. However, the initial discharge current is always limited by the max. discharge performance or the max. discharge current of the **nextGeneration** which depends on the cell count, the car batteries charge level and/or the temperature of the electronic load.

Low capacity batteries (Rx-battery) or batteries which allow re-charge into the car battery, may be discharged at a lower rate to prevent damage. Recommended constant discharge rates are 1C to max. 2C.

This program will discharge the battery connected to Output 1 down to the discharge voltage (see **Chapter 8.3 Info**).

In contrast to **fix D**, the **autoD** discharge program will automatically decrease the discharge currents towards the end of the discharge. The current (only at Ni-Cd batteries, not at Ni-MH batteries) will be reduced in steps and finally turned off. This way, the Ni-Cd cells may be discharged to a lower level. A buzz or a melody will be activated for a short time.

8.5 Ni-Cd/Ni-MH battery conditioning programs (autDC, fixDC)

This program starts with the discharge program after the battery is connected and switches automatically to the charge program when battery is discharged. This program is intended to erase any memory effect and is particularly suited to freshen up (e.g. once a week) Tx and Rx-batteries which are usually never completely discharged in normal use.

This program starts with the discharge program (**autoD** resp. **fix D**). After reaching the "empty"-voltage level the **nextGeneration** automatically runs the **autoC** resp. **fix C** program in sequence.

Please read the descriptions of the individual programs to understand the way they work and how to set the currents.

For new or irregular maintained batteries a single discharge/charge-cycle may not be enough to achieve a complete formatting of the cells. In this case the **aut2DC** resp. **fix2DC** up to **...5DC** provides the option of automatically running cycles. The **...5DC** (= "**...XDC**") program stops the cycles when the max. discharged capacity (discharged quantity) has decreased.

These programs will finish like a **fix C** resp. **autoC** program, with buzzer.

Only the usual charge data, but no information about the discharge cycle will be displayed on graphic display after the program had finished.

The **info** menu will show the capacity values of all charge/discharge cycles.

8.6 Ni-Cd/Ni-MH capacity measuring program (autCD, fixCD)

This program starts with the charge program charging after the battery is connected to the battery 1 output and then discharge down to the "empty" voltage level.

This program enables you to monitor the performance of your batteries during their lifetime, allowing you to estimate their usefulness.

This program starts with the charge program (**autoC** resp. **fixC**). After reaching the "full"-state the **nextGeneration** automatically runs the **autoD** resp. **fix-D** program in sequence.

Please read the descriptions of the individual programs to understand the way they work and how to set the currents.

The programs also can run automatically for up to 5 times. The **...5DC** (= "**...XDC**") program stops the cycles when the max. discharged capacity (discharged quantity) has decreased.

At the end of the discharge the graphic display will show discharge time, discharge voltage and capacity, and a buzz or a melody will be activated for a short time.

The **info** menu will show the capacity values of all charge/discharge cycles.

9 Lead-battery programs (lead-acid, lead-gel "VRLA")

The lead-acid battery charge programs all bear the designation "**Lead**" in the battery type designation. If you select this battery type you can charge and discharge lead-acid and lead-gel batteries.

Lead batteries behave entirely differently from sintered-cell Ni-Cd batteries, which are commonly used as power sources in model aircraft, cars and hydro-boats. Lead batteries can only supply relatively low currents relative to their capacity if you wish to exploit their full capacity, otherwise the voltage falls off to an excessive extent. The same also applies to charging: the battery manufacturers usually state **20 hours** to reach full nominal capacity (charge current **0.1 C**, voltage limited).

The lead charge programs of the **nextGeneration** charger provide a steadily rising charge current which gradually declines again when the battery's maximum voltage is reached.

The charge programs provided by the charger are capable of giving lead batteries virtually a full charge in just a few hours. The appearance of an "**a**" on the screen after the charge time display indicates that the charge voltage has reached its maximum and the charge current decreased essentially. At this point the battery is around 4/5 fully charged, and the process of charging the last 20% occurs much more slowly. Further increase in capacity is indicated by the appearance of the letters "**b**" and "**c**" as the current falls back further. The time between the "**a**" point and the full display (when the charge current is switched off) may be almost as long as the time between connecting the battery and the appearance of the "**a**". The buzzer sounds briefly when the "**full**" display appears.

9.1 Lead battery charge program Fixed-C (fix C)

Set a charge current of around 0.4 C (see Chapter 4).

If you are ever in doubt about this, always follow the instructions supplied by the battery manufacturer, as they do not necessarily agree with our suggestions, nor those of the importer or your model shop!

The charge phase begins with a period when the battery is 'balanced'; this is indicated by a flashing "**+**" preceding the current value.

If you see no "**+**", this indicates that the charger has reached the nominal charge current, and will not rise any further. If the screen displays a "***" constantly, this means that maximum charger power has been reached.

9.2 Lead battery discharge program Fixed-D (fix D) not at the batt 2 output)

For an accurate capacity measurement of your batteries please use a discharge current of around 1/10 C; for other purposes you can set any current within the permissible discharge currents for the battery.

9.3 / 9.4 Lead battery combi-programs FixedDC and FixedCD (not at the batt 2 output)

These programs are a combination of the charge and discharge programs.

...DC means that the battery is first discharged, then recharged; **...CD** means that it is first charged, then discharged. It is possible to carry out these combination programs repeatedly in sequence: when you select a combination program, the charger asks whether you wish to select up to **five** DC or CD cycles.

If you set five cycles, the **nextGeneration** will also interrupt the combi maintenance program if it detects that the charge quantity removed from the pack is less than in the previous cycle.

Notes

- Don't be surprised if the **nextGeneration** charger already shows full when the battery has reached around 70% of its nominal capacity. The reason is that the nominal capacity (i.e. useful life) of a lead battery is very quickly reduced by incorrect handling (overcharging, many 100% discharges, and especially deep-discharges). For more information please read the instructions supplied with your battery.
- If you connect a battery which is already three-quarters full, or is exhausted (i.e. reduced nominal capacity), it will not be charged at the current you have set in the charge current menu, as the battery reaches its maximum permissible voltage before the selected maximum current is reached.
- During the charge process the charge voltage limit is reduced after a certain time to the voltage value for continuous charging (approx. 2.275 V / cell). In this case the **nextGeneration** generally alerts the user by displaying the message "wrong cell count" for a few seconds.

10 Lithium-Battery Programms (Li-FePo₄, Li-Ion, Li-Po)

The Lithium battery charge programs all bear the prefix "Li" in the battery type designation. As explained in Chapter 4, there are currently three different types of Lithium battery in common use by modellers.

The new Li-FePO₄ cells (Lithium-Iron-Phosphate; known as e.g. Saphion, A123) can be charged using the **nextGeneration** in exactly the same way as Lithium-Ion and Lithium-Polymer cells. However, it is essential always to set the correct cell type in the menu, so that the charge or discharge data match your battery (do not charge Li-Fe cells using the Li-Io or Li-Po program).

The Lithium charge programs of the **nextGeneration** charger provide a steadily rising charge current which gradually declines again when the battery's maximum voltage is reached.

Note: If you connect a battery which is already full or almost full, it will not be charged at the current you have set, as the battery reaches its maximum permissible voltage before the selected maximum current is reached.

The charge programs provided by the charger are capable of giving Lithium batteries virtually a full charge in just a few hours. The appearance of an "a" on the screen after the charge time display indicates that the charge voltage has reached its maximum and the charge current decreased essentially. At this point the battery is **around 4/5 fully charged**, and the process of charging the last 20% occurs much more slowly. Further increase in capacity is indicated by the appearance of the letters "b" and "c" as the current falls back further. The time between the "a" point and the "full" display (when the charge current is switched off) may be almost as long as the time between connecting the battery and the appearance of the "a". The buzzer sounds briefly when the "full" display appears.

10.1 Lithium battery charge program "fix-C"

Set a charge current of around 1 C (see Chapter 4).

If you are ever in doubt about this, always follow the instructions supplied by the battery manufacturer, as they do not necessarily agree with our suggestions, nor those of the importer or your model shop!

The charge phase begins with a period when the battery is 'balanced'; this is indicated by a flashing "+" preceding the current value.

If you see no "+", this indicates that the charger has reached the nominal charge current, and will not rise any further. If the screen displays a "*" constantly, this means that maximum charger power has been reached.

10.2 Lithium battery discharge program "fix-D" (not at the battery2 output)

For an accurate capacity measurement of your batteries please use a discharge current of around 1/10 C; for other purposes you can set any current within the permissible discharge currents for the battery.

10.3 / 10.4 Lithiumbattery combi programs "fixDC" and "fixCD" (not at the battery2 output)

These programs are a combination of the charge and discharge programs.

...DC means that the battery is first discharged, then recharged; ...CD means that it is first charged, then discharged. It is possible to carry out these combination programs repeatedly in sequence: when you select a combination program, the charger asks whether you wish to select up to five DC or CD cycles.

If you set five cycles ("...XDC"), the **nextGeneration** will also interrupt the combi maintenance program if it detects that the charge quantity removed from the pack is less than in the previous cycle.

10.5 Hints for the use with external balancers / equalizers

The "full" indication with Lithium or Lead-acid batteries applies when the charge current has reduced to a fraction of the selected value. This value is set to about 100 mA - even if the calculated value for "full" should be below that figure. This ensures that the balancer's own current drain, which is drawn from the battery being balanced, does not prevent the charger indicating "battery full".

Note: When a battery of low capacity is fully charged, it should always be disconnected from the balancer (and from the charger) once the charger has cut off the charge current. This will avoid the balancer's own current drain discharging the pack.

11 Charging/discharging of Ni-Cd / Ni-MH transmitter batteries

Many transmitters are fitted with discharge protection diodes (short-circuit guard diodes). There are two options here: you can either by-pass the diodes in the transmitter, or you can set the parameter "diode" to "ON" for the charge process in the parameter menus "1" or "2".

The diode prevents the charger detecting that a battery is connected for charging, so you must start the charge process manually by pressing the <+> button (also shown in the display).

Since the battery 2 sockets have no voltage converter, in theory this output could be used to recharge a battery in a transmitter whose electronics remain connected to the battery during the charge process (i.e. not disconnected by the On/Off switch) while the charge voltage can never be higher than the car battery voltage.

However, you must understand that it is fundamentally dangerous to charge a battery in the transmitter, as the battery could even explode, causing serious damage. We therefore advise you never to do this.

12 Special hints

12.1 Connection order of Lithium packs with balancing leads

The connection of Lithium batteries with balancer leads should be done in following chronological order:

12.1.1 Connect the balancing socket first.

12.1.2 Then connect the neg. contact of the charging lead to the charger "-" socket.*

12.1.3 Last of all connect the pos. contact of the charging lead to the charger "+" socket.*

[*] or connect the neg. lead and the pos. lead of the charging cable at the same time.

12.2 Special hints for charging 1-3 Nickel cells

Note following safety warnings and hints:

Charging: Normally buzzer and display warns when cells are connected which voltage are too low.

After about **30 seconds**, charging cycle will be finished, if charging voltage does not increase above a certain value. These warnings and the previous switch off can be **oppressed** when pushing the <+> button within the first 30 seconds of charging. When pushing the button, you must be in the corresponding graphical **pack 1** or **pack 2** screen.

Warning: Voltage peak of the cells is not very high when charging less than 4 cells. Cut of automatic function is not guaranteed. It is possible, that the peak cut off automatic stops charging too early, too late or not.

Discharging: No special procedures necessary.

12.3 Procedure for storing Lithium cells

12.3.1 How it works:

The storage program for lithium packs is only available on the battery one output. The lithium battery will be discharged or charged (depending on their charge state) to a cell voltage which is calculated from the minimum and maximum voltages of the cells which are shown in the „ParameterSet2 nextGen“ (e.g. uLiPo + ULiPo / 2 = *3000 + *4200 / 2 = **3600 mV**).

12.3.1 Parameter selection:

In the „ParameterSet battery1“ you have to select first all fitting parameters for your battery pack and finally you have to change the parameter „stora“ge to „YES“.

Hint: When you change the battery type or unplug it then this parameter is setted back to „NO“.

12.3.2 Display:

State display (Press one or two times <info>): 1st line as usual, but the calculated storage voltage is displayed in the middle of the second line. The full-/empty-message is: „STORAG“.

13 Automatic Cut-off Circuit

Before we discuss the various methods of automatic charge termination, you should be aware of a few basic facts:

In most cases selecting the „*cutOf:norm.*“ setting gives the best results with genuine Ni-Cd sintered cells (not hybrid cells).

In the "*strict*" setting, especially with the automatic programs, the charger sometimes fails to detect the Peak and is therefore not available with Ni-MH programs. Ni-MH batteries are generally charged using the sensitive ("*sens.*") setting.

Lead and Lithium batteries are switched off when the maximum charge voltage ("*U-max*") is reached, and the charge current declines to a fraction of the selected current.

13.1.1 OFF: no Delta Peak (Delta-U) cut-off

In this mode continuous charging is possible, as the automatic Delta-Peak circuit does not switch off the charge current.

For safety reasons the charge current ("*cCurr*") is automatically set to 100 mA when you select "*OFF*" (**battery overheating risk**), or if the temperature sensor is disconnected when "*ON*" is selected.

If no battery is connected to the charger, the value of "*cCurr*" cannot be increased.

If a battery is connected, the charge current can be increased to a maximum of 500 mA while the battery is on charge.

13.1.2 sensitive: Delta Peak cut-off for flat voltage reduction

"*sens.*" : Delta Peak cut-off with sensitive characteristic:

This automatic termination method switches off the current when the final charge voltage curve reaches a plateau (flat), as is commonly encountered with hybrid Ni-Cd cells or Ni-MH cells.

Usually this setting provides the most straightforward method of charging Ni-MH batteries.

It can occur that the charge process is switched off automatically right at the start of the process if you try to recharge a pack of deep-discharged cells. You can avoid this by entering a delay time (in minutes) for charge termination - the parameter is "*delay*". At the start of the charge process a delay period has to elapse before the automatic cut-off circuit become active, i.e. it only comes into force after the set number of minutes.

Caution: if the delay time is active and you connect cells which are already full (to give them a "top-up") they will probably become very hot because the cells are charged initially without peak monitoring.

This cut-off mode can be used with or without **temperature monitoring** (see **Chapter 14**).

13.1.3 normal: Delta Peak termination for normal voltage reduction

"*norm.*" : Delta Peak cut-off using well-proven termination criteria.

In most cases this setting is the most straightforward method of charging Ni-Cd batteries.

This cut-off mode can be used with or without **temperature monitoring** (see **Chapter 14**).

13.1.4 strict: Delta Peak cut-off for high voltage reduction

"*strict*" : Delta Peak termination with very strict termination criteria.

This automatic cut-off method should only be selected if you experience premature terminations when using the "*norm.*" setting. For example, this might occur with deep-discharged 1700 mAh N-SCRC cells.

Warning: this method of charge termination is particularly unlikely to work properly with packs of selected cells.

When hybrid cells are used with the "*autoC*" program, the charge current is reduced so markedly towards the end of the charge process that under certain circumstances no detectable voltage peak occurs at the end of the charge. This means that the automatic cut-off circuit is not triggered.

This mode cannot be selected for Ni-MH batteries.

This charge termination mode can be used with or without **temperature monitoring** (see **Chapter 14**).

13.2: Delay for the Delta Peak (Delta-Volts) cut-off (will be activated after a time delay)

Activating "*delay*" generates a delay time of 1 minute (standard), 5 minutes or 9 minutes. This period has to elapse before the peak termination circuit is activated.

Caution: if the delay time is active and you connect cells which are already full (especially if you are using the fully automatic Ni-MH program) they will become very hot because the cells are charged initially without peak monitoring.

Note: the Peak monitoring circuit itself also takes at least one minute to gather the battery's charge data, assess the information, then switch off the charge current.

14 Monitoring and safety facilities

The charger contains two types of monitoring and safety facilities:

- 1) Those which protect the device itself, e.g.: over-temperature of the charger or the maximum charge performance control to avoid over-heating of the **nextGeneration**, and
- 2) Those which protect the batteries connected.

For those under 1) please see **Chapter 20**, for those of 2) read this chapter.

As already mentioned in **Chapter 7 - The first Step** - correctly set safety facilities may prevent damage/destruction of your battery in case of cut-off automatic malfunction.

But be aware: Incorrect set-ups may not be able to prevent over-charge and may even cause premature cut-offs.

14.1 Temperature monitoring (only with optional „nextConn“ module)

Temperature monitoring can be used for charge- and discharge programs.

14.1.1 Assignment of the temperature sensor to Battery 1 and/or Battery 2:

This parameter is set in the parameter menu point **"temp>:"** for battery 1 or battery 2. It can be reached via the button <1> or <2> depending on the desired output.

Note: The parameter has always to be set to **"OFF"** when the nextConn module is not built in or the temperature sensor is not connected.

14.1.2 Selecting the cut off temperature limit

The max. temperature limit can be set in the chargers parameter screen1 via the button <par> (press <par> one time) and then selecting and adjusting the parameter **"temp>:"**.

The temperature values can be adjusted in steps of 2°, the resolution of the sensor. To switch from odd to even values you just have to go for the limits. The upper limit will turn to even, the lower limit to odd numbers.

Only **one** temperature sensor is available, but it can be used in many different ways.

14.1.2.1 If the sensor is not assigned to any of the two outputs, it will turn off the **nextGeneration** itself when the selected temperature plus 30°C is exceeded.

14.1.2.2 The sensor can be assigned to any of the two outputs.

14.1.2.3 It is also possible to assign the sensor to multiple outputs. This makes sense if the sensor is used for emergency cut-off at 75°C. At 'normal' cut-off temperatures of 45°C all assigned outputs would be turned off, independant of their state of charge, as the sensor can only monitor one battery.

14.1.3 Activation display:

The activated temperature display is shown on the graphic screens.

If the active display shows **"-°C"**, this indicates that the temperature sensor is not connected, or there is a cable fracture, and the charger emits a warning signal. If a battery is connected, it is not charged; if this occurs while a charge process is under way, it is interrupted with the message **"TmpSns"** in the curve screen.

If temperature monitoring is active, it is important to ensure that the battery temperature is below 41°C at the start of the charge / discharge process. If the temperature is higher than this, the charge or discharge process is not initiated; the **nextGeneration** waits until the battery has cooled down. A message **"temp.lim"** (temperature limit exceeded) appears on the screen.

14.1.4 Hints

- It is up to you to attach the temperature sensor to the correct battery pack !!!
- Never use Temperature-cut-off on PB-batteries, as it will more likely lead to the destruction of the battery rather than to a proper charge. Selection of excessive charge currents or constant charges exceeding the max. voltage will cause permanent damage (loss of capacity) or even destruction of the battery.
- Using Temperature cut-off for Combination programs (DC, CD, 3DC, 2CD ...) without Delta-peak monitoring (**"cutOf: OFF"**), the battery temperature must not exceed the cut-off temperature during discharge (Select a low discharge current, otherwise the cut-off will cause a premature end of the discharge cycle).

If Delta-peak monitoring is activated, exceeding the selected temperature will cause an emergency cut-off.

- Disconnected temperature sensors or sensors with defective wires will stop the program together with the **"TmpSns"** message.

14.1.5 Control

Activated temperature monitoring can be identified by normal letters on the curve screens. If temperature monitoring is inactive, the value is displayed in parenthesis.

14.1.6 Messages

If programs are terminated because the set temperature values are exceeded, the display will show **"TEMP"** instead of the usual "FULL" or "EMPT"y message. When using a combination program (only output 1), **"TEMP"** means in this case: (dis-) charging interrupted, not really empty/not really full. If the battery temperature is higher than 40°C (not adjustable) before a discharge phase, the discharge is not initiated. In this case the screen displays the message **"temp.lim"** until the battery temperature falls below 40°C.

14.2 (Charge-/Discharge-) Quantity monitoring

For activation and set-up of this **"quan>:"** function, press <1> or <2> to change into the parameter menu screens for battery 1 or battery 2. The display shows the unit **mAh**.

14.2.1 The charge quantity must be selected for all battery types and for all charge outputs separately.

14.2.2 You can also limit the discharge quantity by the value of the charge quantity monitoring if you couple the functions. To do this you have to switch to the parameter set1 screen (press <par> one time) and then change the parameter **„dQuan:“** to **„ON“**.

14.2.3 The procedure to set the charge quantity is very easy: Just add about 10% ... 30% to what it takes to charge your battery and program this value to the **"quan>:"** parameter. **"OFF"** means, that quantity monitoring is disabled.

14.2.4 Meldung: If programs are terminated because set charge quantity values are exceeded, the display will show **"QUAN"** instead of the usual "FULL" or "EMPT"y message.

14.2.5 Example: A selected 2400 mAh cell requires about 2.7 Ah for a complete charge. The safety cut-off for this type of battery should be set at a minimum of 2800mAh.

If the charge is frequently terminated by the charge monitoring function, the set value may need to be increased. Be reminded that a partially charged battery will not be able to consume a full nominal capacity charge (To avoid the memory effect you should discharge your batteries anyway).

Please bear in mind that it is not possible to charge the full nominal capacity into a battery which is not completely discharged beforehand (however, to minimise the memory effect you should really ensure that the cells are completely discharged first, right down to the final discharge voltage).

14.2.6 Double function

The automatic current calculation feature has exclusively in combination with the Nickel-Metal-Hydride charge programs with automatic current calculation (NiMH - autoC, autCD, XautCD, XautDC, autoDC) an important double function:



14.2.6.1 First an explanation

In comparison with the Ni-MH cells of the last few years (e.g.: Sanyo RC3000H/3300HV, KAN 950, Panasonic HHR-300SCP/350SCP (3,0/3,5 Ah)), modern Ni-MH cells (e.g.: Intellect 3800 & 4200, GP130/370/430SCHR (1,3/3,7/4,3 Ah)) exhibit an enormous reduction in internal resistance, due in particular to improved contact techniques between the internal cell winding and the surrounding container as well as to changes in the chemical make-up of the cell.

Since - unfortunately - the automatic current calculation circuit is unable without outside help to detect which generation of cells is connected to it, we have incorporated a special feature in the automatic current circuit as of software Version 8.50:

After the initial charge phase, as described in Version 8.xx (which is still carried out at a very high current, and could previously be limited only by the menu point "C-Curr"), this feature limits the charge current to a maximum value which you define.

14.2.6.2 Setting the maximum charge current value

A new menu point is not required for this. Instead the maximum current value corresponds to the maximum charge quantity which you define for the safety charge cut-off circuit (e.g.: 1000 mAh = 1000 mA). This value should correspond to the battery's capacity value, plus a certain addition to allow for poor charge efficiency, as previously. This addition should be in the range 20% ... 50%, as shown in the table values for the safety cut-off circuit.

14.2.6.3 Safety notes



It is essential to set the maximum charge quantity correctly, as this is the only way to ensure that the automatically calculated charge current does not exceed the stipulations for charging **Ni-MH** batteries, as stated in Section 4.3, of around 1 C ... 1.6 C. This is necessary to prevent the battery overheating.

If the charger should switch off by "quantity" when connected to brand-new or deep-discharged cells: please don't connect the pack again for charging. Instead carry out a discharge process first (e.g. using the Auto DC program).

Please also note that you must NOT use the automatic current calculation feature to charge the high-capacity cells mentioned towards the end of Section 4.3, as this will result in the calculation of an excessively low current (below 1 C), which would cause the charger to detect the "battery full" condition incorrectly.

14.3 Charge time monitoring

As the name implies, this function is limited to charge programs.

For activation and set-up of the function press at first <1> or <2> to get into the ParameterSet menu. Then select the desired maximum charge time in the „**time**>:“ menu.

14.3.1 The charge time must be selected for all battery types and also for both charge outputs separately.

14.3.2 Setting the max. charge times is quite easy: Just add about 10% ... 20% to what it takes to charge your battery and program this value.

"OFF" means that time monitoring is disabled.

While the expected charge time can be easily estimated for the "**fix_C**" programs, the times in "**autoC**" will vary according to the calculated charge current.

Still, checking the charge times in automatic mode may give you an indication on the condition of your battery: Fit batteries require less charge time.

For comparison you have to ensure similar conditions: Identical charge lead (2.5mm²) and similar temperatures of batteries and surroundings. Cold batteries take longer than warm batteries.

If programs are terminated because set charge time values are exceeded, the display will show "**TIME**" instead of the usual "**FULL**" or "**EMPTY**" message.

14.4 Note

All the mentioned adjustments will be stored in the **nextGeneration's** non-volatile memory and will be readily available even after the device has been disconnected.

15 Monitoring functions on the LCD-panel

15.1 Charge-/discharge current maximum load control display for output 1 and 2

If the current in the graphical displays figures during charge/discharge are lower than expected, usually the charger has automatically reduced the current because a limit has been reached. For example: When reaching the maximum performance of the voltage converter of the charge/discharge stage, the display will show a "***" in front of the current display.

15.2 Discharge / energy re-transfer control display for output 1 and 2

Discharge currents are marked with a "-" in front of the current display in the curve screen. Energy is re-transferred into the car battery (or a power supply).

15.2.1 If the charger reaches one of its limits and has automatically reduced the current below the manually selected discharge current or automatically calculated discharge current, the "-" will intermittently be replaced by a "***".

15.2.2 If the internal electronic discharge load is switched on caused by a fully charged car battery or the use with a power supply, the "-" will intermittently be replaced by an inverse "R" (or "***" and "R").

15.2.3 If the car battery is absolutely full even when the internal electronic discharge load works, then the discharge current is reduced to avoid overcharging the car battery or damaging the power supply. The "-" will intermittently be replaced by an inverse "A" (or "***" and "A").

15.3 Status display for output 1 and 2

An overview about the status of all connected batteries and especially the combined programs the information display is located in the "**info**" screen „**State: b1...**“.

(press „**info**“ 1 time of 2 times - that depends if a balancing socket is connected or not. Chapter 15.5)

It shows which combined program has been selected, which part of it is currently running (charge or discharge) and which phase of the xDC resp xCD program is running: Up to 5 cycles are displayed one below the other. The values of battery 1 on the left 2/3 of the screen, those of battery 2 output on the right side.

The display also shows the internal resistance of the batteries (**note**: including the resistance of all connectors and charge cables and cables inside the battery!).

15.4 Informations around the car battery

The car battery information display is located in an other "info" screen „**State info nextGen.**“ (press „**info**“ 2 time of 3 times - that depends if a balancing socket is connected or not. Chapter 15.5)

This screen display finally lets you know for certain what you can expect of your car battery or mains power supply when fast-charging your batteries, and what quantity of energy is removed from your car battery in a single day. This display also allows you to check whether the specified wattage has produced the desired current limiting in conjunction with the cell count in use when you are using the charger with a mains power supply.

15.4.1 The **car battery voltage** is displayed at „**Input Voltage**“ and refreshed instantly.

15.4.2 The **car battery current** is displayed at „**Inp.Curr.Draw**“ and refreshed instantly.

- If no battery is connected to output 1 or 2 , only the power consumption the **nextGeneration** device itself (quiescent current = 120mA) is indicated.
- Is the input current negative, then no consumption from the car battery (or from a power supply) takes place but this indicates a re-energy transfer into the car battery from a battery which is discharged at the battery 1 output.

15.4.3 The **power consumption from the car battery** is displayed at „**TakenCapacity**“ and refreshed instantly.

- If the „**TakenCapacity**“ decreases or is negative, then no consumption from the car battery (or from a power supply) takes place but this indicates a re-energy transfer into the car battery from a battery which is discharged at the battery 1 output.
- When the **nextGeneration** is connected to the car battery the old power consumption (mAh, Ah) is restored.
- The clearing of the accumulated value is manually possible at the menu point "**carBt:reset**" in the chargers „**par**“-ameter set 2 (press <par> 2 times).

15.4.4 The current- and quantity indication for the primary energy source (car battery / mains power supply) is a calculated value, which is matched quite well with the reality.

15.5 Display of the Lithium balancing single cell voltages

Please press 1 x „**info**“ when the graphical screen is present and the balancing socket is connected. In each line the cell number, the cell voltage in mV and the voltage difference of the cells referred to the cell with the highest voltage is displayed in mV (all cells will be equalized to the cell with the highest voltage). Since only 8 cell voltages can be displayed simultaneously the screen can be scrolled by pressing the „+“ or „-“ buttons. (See Fig. 15.5 on page 38)

16 Special adjustments

16.1 Selection of the min. voltage limit warning (when operating from a car battery)

When using an external battery which is not used for starting the car, it can be discharged to a lower voltage level. In the device parameter set 1 (press <par> 1 time) and the menu „**batt<**“ you can change the threshold value for the low-voltage warning. Based on years of experience "with start up reserve (not guaranteed)" this value is set at "****11.2 V**". In this case the "******" stands for recommended value. The **nextGeneration** will stop all operations if the supply voltage drops about 500 mV (0.5 volt) below this value and will display an appropriate error message.

16.2 Resetting the display of car battery discharge quantity

The clearing of the accumulated value is manually possible at the menu point "**carBt:reset**" in the second parameter set screen (press <par> two times).

16.3 Operation from a car battery charger (see also power supply operation 16.4)



Never connect the **nextGeneration** directly to a car battery charger as it will be damaged. Even when using a car battery as a buffer the remaining peaks from the car battery charger may cause the **nextGeneration** to display irregular error messages and/or may work with reduced power.

16.4 Operation from an AC/DC power supply

16.4.1 Although operation from a well stabilized Power Supply is possible, it is not recommended due to the **nextGeneration's** high performance and its capability of energy re-transfer (in this case into the power supply) which may cause damage to the power supply and/or the charger.

Hints: The requirement is - in every case - an output current of minimum 6 amperes. Adjustable power supplies must be adjusted to maximum 13.8 volts, not higher.

16.4.2 Our mains power supplies

NT-16A (for next-6.30),

NT-25A (for next-6.30, next-7.36 and next-10.36), and

NT-40A (for next-6.30, next-7.36 and next-10.36) has been tested with the **nextGeneration**.

16.4.3 Limiting the current consumption in the device parameter set 1 (press <par> 1 time):

Via the menu-items "**curr<**" the maximum input current draw can be limited to lower values to keep the current from the mains power supply (as well as from a car battery) below the maximum.

16.4.4 Limiting the power consumption in the device parameter set 1 (press <par> 1 time):

Via the menu-items "**powr<**" the maximum charge power can be limited to lower values to keep the maximum input current draw from the mains power supply (as well as from a car battery) limited.

Only the charge power of output 1 is limited because of the minor importance of the current draw of output 2 in comparison to output 1.

Hint: Because of the fact that both parameters (in 16.4.3 and 16.4.4) results in the same the **nextGeneration** will work with those which leads to the lowest input current draw.

Caution: set the charge power so that the permissible continuous current of the mains power supply is not exceeded.

(Note: if you are using one of our recommended mains power supplies listed in chapter 16.4.2 there is no need to reduce the power).

In any case it counts that the stated maximum current of the mains power supply must be greater than or equal to the actual current drain of the nextGeneration.

For this reason the input current draw display is very helpful for establishing the primary current drain (press 2 times <info> to switch into the „**State Info nextGen.**“ screen.

Safe operation of the **nextGeneration** from an AC/DC Power Supply may be effected by further factors like ripple-voltage, continuous power performance, compatibility with the frequency of the voltage converter, adequately sized capacitors (an area where laboratory power supplies sometimes show deficiencies) etc.

It is the responsibility of the operator to check the reliable function of the combination power supply and charger. We can not be held liable for problems and damages resulting from unsuitable combinations

16.5 Programm after PowerOnReset

When the charger is connected to a power source your charger starts with the last used program.

16.6 Fan output (only with optional „nextConn“ module)

The configuration menu for the fan output „**fan <**“ is located in the parameter set 1 screen for the charger „**ParameterSet 1 nextGen**“ (press <par> 1 time).

You can chose between „**ON**“ (= external fan switched on) or „**OFF**“.

The fan (not included in the kit of the nextConn module) can be used to cool hot batteries.

The fan output switches the car battery voltage with a load of up to 2 amps (The maximum current draw of the blinking output plus the fan output is 3 amps together).

Hint: The internal fan can not be influenced by this parameter but it is temperature controlled by the internal temperature of **the nextGeneration**.

16.7 Blinking light output (only with optional „nextConn“ module)

The configuration menu for the blinking light output „**light<**“ is located in the parameter set 1 screen for the charger „**ParameterSet 1 nextGen**“ (press <par> 1 time).

You can chose between „**continON**“ = light is continous on, „**blinking**“ = blinking light, oder „**OFF**“.

The light (not included in the kit of the nextConn module) can be used to signal the driver or the pilot in far distance that the battery is fully charged or empty.

The blinking light output switches the car battery voltage with a load of up to 2 amps (The maximum current draw of the blinking output plus the fan output is 3 amps together).

The signal output (and the buzzer) can be switched off by pressing the <+> key.

16.8 external Temperature sensor (only with optional „nextConn“ module)

A detailed description is given in chapter 14.1.

16.9 Refresh

The Refresh option is only available for output 1 and can be chosen in the battery one parameter set (press <1> then select "refr.:").

Refresh charging is supposed to get older, stored or intermittently used batteries faster up to speed and is particularly suited for Rx- and Tx-battery maintenance.

We do not take part in advertisement myths: A healthy battery will not become fuller than full. Using refresh you probably will not detect any increase in capacity or any decrease in internal resistance on properly maintained batteries.

Refresh is turned off in "diode" charge modes. It is not possible to charge batteries with an additional discharge protection diode in refresh mode.

When you are balancing Lithium batteries, Refresh mode is also switched off.

16.10 Owner's name

The owner's name is displayed every time you connect the charger to a car battery. It can be altered in device parameter menu 1 (press <par> once).

You can alter the name in the menu point "Name". Press <enter>, and a screen appears which shows the available character set (lines 1 - 5), with brief operating instructions in the centre (lines 6 - 7) and a line at the bottom showing the name to be changed (line 8, 21 characters).

Fig. 16.10 Name selection screen

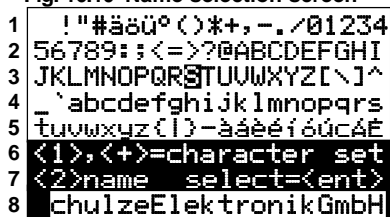

16.10.1 when you open the display, the inverse letter indicator is located at the first character of line 8.

The indicator is moved within the name field by pressing <l> and <r>.

16.10.2 If a character is to be changed, then the cursor must be activated in the top half of the screen; this is accomplished by pressing the <1> button (or optionally <+> - see brief operating instructions in line 6).

The frame previously surrounding line 8 now encloses lines 1 - 5, and the inverse indicator is located at the same letter

in the character set (lines 1 - 5) as in line 7. You can move the indicator by pressing <l> and <r>.

To erase a character, press the <1> button to position the indicator on the space character at top left (first character). Note: pressing the <par> button moves it to the last symbol in the character set, but the "2" button switches the cursor range; see 16.10.4.

16.10.3 Once you have selected the appropriate symbol from the character set (lines 1 - 5), you must press <enter> in the name (line 8) to accept it. The indicator now automatically moves forward in the name by one character, and you can select the next symbol from the character set.

16.10.4 To conclude the name entry procedure you must again activate the cursor in the name field by pressing the <2> button. The outer frame now changes back from the character set fields to the name line. At this point you can provisionally accept the altered name input line by pressing <enter>. However, you must correctly enter the password used until now before the name is finally accepted, and the screen automatically requests you to do this. In the charger's default state the eight-character password is "keyword".

16.10.5 The eight-character password is displayed in the name line (line 8). When you enter the password, the last line always reads "keyword <PasswordEnter>". If you have not yet changed the default password, you simply need to press <enter> (and then change the password as quickly as possible - see Chapter 16.11). Basically you have to replace the word "keyword" with your own password, working letter by letter; the procedure is identical to the one for entering the user's name, as described in the preceding Chapter 16.10.x.

16.11 Changing the Password

The owner's name is secured by a password.

The software automatically requests this password every time the owner's name is changed.

It is possible to change the password independently of changing the owner's name.

16.11.1 In the charger's default state the password is "keyword". This password name is always suggested in the name line 8 (even if you have your own password), and this should be changed as soon as possible to avoid the danger of other users changing your name in the device. The nextGeneration expects a name with a length of eight characters (the space character at the end also counts as a character). It differentiates between capitals and lower-case letters, and also accepts numerals and special characters.

Please take care to remember the name you have entered. If you forget your password, we can restore it at the factory, but only on condition that you prove to us that you are the legal owner of the device sent to us.

16.11.2 The password can be changed in device parameter menu 1 (press <par> once). You can alter the name in the menu point "Password". Press <enter>, and a screen appears which shows the available character set (lines 1 - 5), with brief operating instructions in the centre (lines 6 - 7) and a line at the bottom showing the password to be changed (line 8, 21 characters). The procedure for changing the password is as described in Chapter 16.10.1 - 16.10.4; simply replace the word "Name" with "Password".

16.11.3 First you must enter the old password in order to legitimise the change of password. The password line 8 "keyword <old password>" informs you of this requirement.

16.11.4 The new password must now be entered for the first time.

The password line 8 "keyword <new password1>" informs you of this requirement.

16.11.5 Now the new password must be entered a second time.

The password line 8 "keyword <new password2>" again informs you of this.

16.12 Motor run-in program „Run-In“

As mentioned in chapter 6 the motor run-in program for brushed motors has to be selected in the "bType:" menu.

The maximum motor current has to be set in „mCurr:“ the maximum motor voltage has to be set in „mVolt:“ Depending on the resistance of the motor windings and the rotational speed of the motor one of the two values is reached, the other is lower.

The run-in duration can be limited by two parameters: By „quan>“ and „time>“.

"time>" limits the run-in duration directly in minutes. The effect of "quan>" can be described as if the run-in procedure stops automatically when a battery with a given capacity is flat (empty).

There is another possibility to monitor the run-in procedure if the „nextConn“ module is built-in (standard in the next-7.36-8 and -10.36-8): By means of the temperature sensor you are able to monitor the motor temperature and turn out the motor voltage and motor current if the temperature exceeds the limit.

Hint: "temp>" shown in Fig. 16.12 only activates the temperature sensor and assigns it to battery output 1. The temperature itself must be set in the first device parameter set (press <par> one time).

Battery 1 parameter screen Fig. 16.12

ParameterSet	battery1	
bType	RunIn	cells: 0
prog.	fix_C	eRate: 1.0
mCurr:	3.50A	quan>: 3500
eStrm:	5.00A	time>: 1h30
cutOf:	OFF	temp>: OFF
mVolt:	*4.0V	Diode: NO
stora:	NO	Refr.: OFF

16.13 Melody selection (only with optional melody module plugged in)

The melody-module can be configured via the device parameter set 1. At first you have to select one of 12 melodies (0 = buzzer signals full/empty), then the loudness.

17 Principle of the energy re-transfer functions (limits, warnings)

The charger is capable of feeding energy back into the car battery when a battery is being discharged; this works with battery voltages down to less than one Volt, and is achieved by operating the charger's integral voltage converter so-to-speak "in reverse". Since this method does not convert the excess energy into heat (as is usual), discharge currents can be at the same level as charge currents.

Nickel batteries are best stored in the discharged state, so you can feed energy back into the car battery if your packs are not completely flat from flying or operating your model.

The discharge current starts at zero and increases until it reaches the selected maximum discharge current, or the maximum discharge power of the **nextGeneration**.

If the voltage of the car battery or the mains PSU just reaches 15 V, this will also cause the electronic load to be switched on initially, followed by an automatic reduction in the discharge current if necessary in order to avoid the power supply voltage exceeding 15 V (screen displays "A" before the current display on the graphic screen - see Chapter 15.2).

18 Writing/reading the customer configurations

18.1 Retrieve configurations (read):

Press the <1> or <2> key, depending on the battery output you want to read the parameters.

The configurations itself are located in the "**bType:**" menu.

In the "**bType:**" menu you have to press the <+> key until "**read**" appears.

After you had pressed <enter> you can select one of the configurations (see chapter 25).

Remark: In the (central) selection line the configuration number is replaced by the name of the configuration or a „?“ if the configuration is empty or faulty.

With <enter> you replace the current parameter settings by the stored parameters.

18.2 Store configurations (write):

Press the <1> or <2> key, depending on the battery output settings you want to store.

The configurations itself are located in the "**bType:**" menu.

In the "**bType:**" menu you have to press the <+> key until "**write**" appears.

After you had pressed <enter> you can select one of the old configurations (see chapter 25) to overwrite.

Remark: In the (central) selection line the configuration number is replaced by the name of the configuration or a „?“ if the configuration is empty or faulty.

By pressing <enter> you confirm the number of the storage location.

The **nextGeneration** now expects the input and/or change of the name of the configuration by changing into the name input display.

Similar to the proceeding and display of the keyword input (chapter 16.11) the line 8 ends with the hint that you are just giving a name to a configuration with e.g. number 4 and battery output 2 („Ni . auD10<Config4[b2]"“).

After the confirmation (by <enter>) of the changed configurations name the current configuration parameters are stored into the non volatile memory.

19 Additional sockets (side-mounted pin-board)

19.1 5 V-SIO (included in series)

On the right side of the housing there is a four pin socket which is connected to the 5 volt serial input/outputs to the internal microcontroller (5 V-SIO).

Our "**prog-adapt-uni**" fits to this socket and changes the 5 volt signals to the usually used RS232 signal of the COM port of your PC - which is now able to receive the charge data or discharge data of the **nextGeneration** charger.

Reception and evaluation of the data should be made by the "Akkusoft" program of Martin Adler. This software allows to store the data in global or selective files, recall them and display them graphically, compare curves, transform pack voltages in average cell values, show energy figures, print curves (in color) and much more. A link to this program is located in the download section of the Schulze homepage at "Evaluation Software".

19.2 „nextConn“ Plug-In PCB (optional available)

The **nextGeneration** can be expanded with 4 additional connectors by an additional printed circuit board.

19.2.1 USB connector (only with optional „nextConn“ module)

This connection is equivalent to the functionality as described in chapter 19.1.

The USB connection replaces the 5 V-SIO, i.e. it can not used simultaneously with it..

As a rule it is possible to use the 5 V-SIO when the USB port is not connected to the PC.

19.2.2 Temperature sensor (only with optional „nextConn“ module)

To connect the temperature sensor provided (LM335Z). A detailed description how the **nextGeneration** has to be configured is given in chapter 14.1.



19.2.3 Blinking light output (only with optional „nextConn“ module)

To connect an ordinary car indicator bulb e. g. 12V/25W (depends on the input voltage of the **nextGeneration**) to the included cable.

The light (not included in the kit of the nextConn module) can be used to signal the driver or the pilot in far distance that the battery is fully charged or empty.

The blinking light output switches the car battery voltage with a load of up to 2 amps (The maximum current draw of the blinking output plus the fan output is 3 amps together).

To turn off the light signal (and the buzzer) just press the <+> or <-> key.

The configuration menu for the blinking light output is located in the parameter set 1 screen for the charger „**ParameterSet 1 nextGen**“ (press <par> 1 time) at „**light:**“ (see chapter 16.7).

You can chose between „**continON**“ = light is continous on, „**blinking**“ = blinking light, oder „**OFF**“.



19.2.4 Fan output (only with optional „nextConn“ module)

To connect a fan (e. g. 12 volts / 2.6 watts (depends on the input voltage of the **nextGeneration**) to the included cable. **Note:** the lead with the red stripe is "positive" (+).

The fan (not included in the kit of the nextConn module) can be used to cool hot batteries.

The fan output switches the car battery voltage with a load of up to 2 amps (The maximum current draw of the blinking output plus the fan output is 3 amps together).

The configuration menu for the fan output is located in the parameter set 1 screen for the charger „**ParameterSet 1 nextGen**“ (press <par> 1 time) at „**fan :**“ (see chapter 16.6).

You can chose between „**ON**“ (= external fan switched on) or „**OFF**“.



20 Protection circuits, error-messages and warnings

The **nextGeneration** is equipped with various protection and control circuits to monitor car battery voltage, charger temperature, maximum performance etc.

Exceeding the limits will, in some cases, interrupt the charge (e.g. car battery over-voltage), the cause will be displayed and the buzzer will be activated for a short time.

The symbols < and > may be displayed. '>' means **bigger**, '<' means **smaller**.

As error-messages with description and code #, like '**warning # 5, car battery voltage = min**' are self-explanatory, the table below should be sufficient. The first digit of the code indicates the Output number where an error was detected.

Code:	1-99	Warnings without charge interrupt
	100-999	Error, interrupt of all programs(*)

(*) To reset the charger when an error ≥ 100 exists then the charger must be separated from the car battery/power supply.

Hint: All error- or warning-codes which begins (first digit) with "1" indicates that an error at the output number 1 was detected e.t.c. All messages with a leading "9" indicates an overload of the **isl 8** itself.

Error text with code numbers for	pack 1,	pack 2
Battery voltage below min.	11,	21
Max. Battery voltage exceeded	13,	23
Wrong cell count of Lead- or Lithium battery	17/117,	27/227
Max. Charge current exceeded	161,	261
Max. Converter discharge current exceeded	162,	----
Max. Charge performance of converter exceeded	177,	277
Max. Discharge performance of converter exceeded	178,	----
Max. Device input current (primary current) exceeded		961
Max. Device temperature exceeded		981
Car battery voltage exceeded		906
Car battery voltage at minimum		5
Car battery voltage below minimum		904
Charge -time /-quantity /-temperature /-voltage exceeded	TIME / QUAN / TEMP / Umax	
Temperature sensor activated, but disconnected or broken lead	TOFF	

Some typical user errors will be listed in more detail, which we strongly recommend you to read before sending the **nextGeneration** for a repair as you may simply avoid them:

„BalCabXX is wrong<+>“ (Warning 16, Error 116)

When the Schulze BalCab connector of a Li-Po or Li-Io battery is configured incomplete (current/capacity resistor is missing) and is connected to one of the BalCab-connectors then the charger uses the manually configured charge/discharge current for max. 30 seconds - except when the error warning is consciously ignored(!) and confirmed by pressing the <+> button.



WARNING: When the BalCab is configured to Li-Fe the charger is unable to detect that the resistor is missing. The nextGeneration is charging/discharging with the manually configured battery type(!) and current(!).

TIME, Charge time exceeded

If a battery charges for more than 3 hours, we cannot say, that this is quick-charging. If you use **autoC** program and your battery is not full within 3 hours, autoC did calculate a wrong current (mostly when you charge a receiver pack with the original charge leads).

For correct function of the automatic charge current selection **a charge lead with 2.5 mm² is mandatory**. We recommend the use of a charge lead for the flight pack combined with a short (< 50mm) adapter piece to connect your Rx-battery. The short lead of the Rx-battery normally will not affect the performance, but no on-off switches with build-in charge sockets must be interconnected.

Disconnect Pack x

Error x77, Charge converter performance over maximum
Error x55, Battery voltage over maximum (e.g. > 50V on a 10 cell pack)
other nonsense errors

These and other unexplainable errors the charger may display, when ...

... connected to a car battery with an operating car battery charger.

... connected to an unsuitable Power Supply.

Keep in mind that due to a different environment or situation, even with time consuming tests it may not be possible to find the cause of some error displays.

If there are no malfunctions you will still be charged for the time spent on testing!

Before you return the device for a check, **test it several times connected to a full car battery to ensure the problem has not been caused by reasons mentioned above.**

EMPTY or RPOL (reverse polarity) - Display during Ni-Cd-Program after about 30s.

To delete the memory-effect batteries may have been completely discharged down to 0V (not possible with this device). The charging of these packs is possible, but up to a certain voltage a warning will be displayed.

Attention: The warning mentioned above appears if the voltage does not rise fast enough. This could be an indication of reversed polarity, if a completely discharged battery was incorrectly connected. It may even get 'reverse-charged'.

Hint: The **nextGeneration** can not detect reversed polarity if a pack is discharged to 0V. It will always start a normal charge cycle, normally ending after 30s with the message reversed polarity (Rpol) or deep discharged (EMPTY), if the battery has not reached a minimum voltage by then. For safety reasons you may have to restart the charge program several times, e.g. when using high capacity cells.

- With deep discharged batteries it may take up to ten minutes until the correct number of cells is identified.

Disconnect Packs

This message will be displayed if batteries are already connected to the charger while connecting it to a power source. The device can not decide by itself whether to select a Ni-Cd- or a PB-program or if Output 1 and 2 may be started uncontrolled. The same message will appear if hardware is defective or if during the program the watchdog detects the microprocessor in a state not foreseen by the software (e.g. due to external interference).

21 Important notes

21.1 Charging leads are only to be connected to the appropriate Outputs.

Cross wiring between Outputs may cause short circuits and damage the device and the batteries (even may cause melting or explosion!).

21.2 Transmitters are often protected against discharge by a diode. For quick charge this feature needs to be disabled (see Tx-Manual) or must be charged with the **w.Diode** charge option (see **CutOff** menu).

To avoid possible damage inside the Tx, the charge current must not exceed 1.2A (Graupner mc-18/20). Watch the charge current when using an automatic program. The resistance of the printed circuit board may cause the microprocessor to select a charge current too low for safe peak detection.

When in doubt: Choose manual selection.

Warning: with large-capacity batteries it is not possible to set a charge current of 1 C or 2 C as required for reliable Peak termination, and for this reason we strongly advise you not to charge the transmitter battery in the transmitter!

21.3 A common cause for insufficient charge currents in automatic mode are unsuitable charge leads. The automatic charge current calculation is based on the measurement of the internal resistance of the connected battery. The lower the internal resistance, the higher the possible charge current.

As the charger can only measure the total resistance (internal resistance+ resistance of the leads + resistance of the connectors), for correct calculation of the charge current it is essential to keep the additional resistance at a minimum by using charging leads with adequate cross sections (**2.5mm²**, also for Rx-batteries!), high quality (gold) connectors, and a maximum length of 75 cm.

When using thin charging leads and/or on-off switches with build-in charging sockets on low voltage batteries, the additional resistance of the connectors and cables could be higher than the actual battery resistance. In this case the automatic charge current would be less than half of what it should be! In such cases manual current selection is recommended. The microprocessor will also consider the condition of the cells when calculation the charge current in automatic modes.

21.4 Don't be amazed if your battery packs seem to absorb lower currents in automatic programs during the winter months - a cold cell does not perform like a warm one.

21.5 If the charger technically can not provide the charge current manually selected or automatically calculated (see example above, or e.g. 6.0A at 30 cells), a "*" will appear between voltage and current values on the display. In this case the actual charge current will be displayed.

21.6 During the measuring phases (a "!" appears between voltage and current figures), some function keys are blocked. They are also inoperative when the charger has noticed a drop in the charge voltage, so that peak detection will not be disturbed. The cut-off automatic can be monitored: it takes several, closely followed voltage drops before the charge on Output 1 is terminated. **The voltage drops detected will appear as a, b, ...** between charge time and voltage values on the display and can be used as **an indication for the Full-probability**.

With a full battery at this point a "t" indicating trickle-charge will be displayed. To keep the battery full, (only) the Ni-Cd programs use a pulsed current.

21.7 Safety Note: As a standard procedure you should check whether the charged capacity after full indication is about what can be expected. This will allow you to identify any premature full detections and may also avoid crashes due to only partly charged batteries. The probabilities for premature full indications depend on several factors. It happens most likely with deep discharged batteries, low cell numbers or certain battery types.

21.8 Especially on low cell numbers you should perform some test charges to verify correct peak detection. Full batteries may become over-charged if the peak is not very pronounced.

21.9 If an **error** (not a **warning**) appears, all current programs will be interrupted.

21.10 You risk malfunctions and damage to the device, if...

- ... switches or fuses are used between charger and battery
- ... terminal clamps are replaced by others than 4mm gold connectors
- ... the device is operated while car engine is running and/or connected to the cigarette lighter socket.
- ... an unsuitable Power Supply is used

21.11 Lead and Lithium battery charging and displays:

21.11.1 When you connect a Lead or Lithium battery the current rises over a fairly long period (around one minute per Ah of capacity or per Amp of current).

21.11.2 The phase when the charge current is rising is indicated by a flashing "plus" symbol preceding the current value. If no "+" is displayed, the nominal charge current has been reached, and will not rise any further.

21.11.3 A constant (non-flashing) asterisk (*) indicates that the maximum power of the charger has been reached (charge voltage too high for the selected current).

21.11.4 It may take several seconds before the software detects the disconnection of a PB-battery. This is for technical reasons is to be considered normal.

21.11.5 Intended side effect: When a Lithium battery is connected to charge it but it's cell voltage is below the voltage which is configured in the "**ParameterSet2 nextGen**" Li-discharge voltage level (**Chapter 23.13.5/6/7 le**), then the battery is treated with care. It will be charged up to the configured "**empty**" voltage level using only one tenth of the configured charge current.

A "*" appears in the graphical display (LCD) between the voltage value and current value. When the battery voltage exceeds the voltage limit, then the charger uses the full (configured) current.

22 Legal matters

22.1 Warranty

All **Schulze devices** are carefully checked and tested before dispatch.

If you have a complaint, send the unit back to us with a clear description of the fault. A message such as "doesn't work properly" or "software error" doesn't help us much!

For all supply of warranty services our Terms of Sale and Supply are applicable (see Schulze Homepage).

One further note:

If a problem arises with any **Schulze** product, send it directly to us without interfering with it in any way.

Changes or extensions of the device can lead to additional costs if these impede or prevent services.

Non-suitable components will be replaced or build back to the delivered condition at the owners expense without any consultation.

This ensures that we can repair the unit quickly, pick up warranty faults without any dispute, and keep costs to a minimum.

You can also be sure that we will fit genuine replacement parts which will work properly in your unit. Unfortunately we have had bad experience with third-party Service Centres which claim technical competence. Note also that any out-side interference with our products invalidates the warranty. Incompetent attempts at repair can cause further damage. We often find it impossible to estimate the repair cost of devices in such condition, and in certain circumstances we are then obliged to decline to repair it altogether.

22.2 CE approval

All **Schulze devices** satisfy all relevant and mandatory EC directives:

These are the

EMF directive 89/336/EWG from 03 May 1989 plus additional changes
up to 03 January 1994

The product has been tested to meet the following basic technical standards:

Interference radiation:
DIN EN 55014-1: 2003-09

Interference susceptibility:
DIN EN 55014-2: 2002-08

You are the owner of a product whose design and construction fulfill the safety aims of the EC for the safe operation of devices.

The approval procedure includes a test of **interference radiation**, i.e. of interference generated by the charger. This charger has been tested under practical conditions at maximum load current and with a large number of cells, and remains within the interference limits.

A less stringent test would be, for example, to measure interference levels at a low charge current. In such cases the charger would not produce its maximum interference level.

The procedure also includes also a test of **interference susceptibility**, i.e. the extent to which the device is vulnerable to interference from other devices. The test involves subjecting the charger to RF signals similar to those produced by an RC transmitter or a radio telephone.

Cell voltage info Chapter/Fig. 15.5

cellNo.	voltage	diff.
cell 5:	3160,	0 mV
cell 4:	2276,	384 mV
cell 3:	3078,	82 mV
cell 2:	3048,	112 mV
cell 1:	3110,	50 mV

23 Menu overview

Power-On screen (Fig. 23.1):

It shows the device type in line 1, the softwareversion in line 3, the owner's name in line 5 and in the lines 7 and 8 the instructions to change to the second menu language in the second language.

Hint:

If the first and second language ist not Your native language you should check the Schulze homepage or the USB-stick if your native language is available.

Hint:

When you press a <button> the screen changes:

<esc>

Initializes the change of the language. Please follow the instructions of the following screen Fig. 23.2.

<1> -> Fig. 23.3

Battery 1 curve screen (graphic screen).

<2> (23.4, not shown)

Battery 2 curve screen (graphic screen).

Hint:

Operating the <info> key only leads to the state info schreens below when the Power-On screen (23.1) or a battery curve screen is (23.3 oder 23.4) displayed. Cause: In all parameter screens the <info> key works as <enter> button!

<info> -> Fig. 23.5

Battery operating state informations
Line 1: State of battery 1 (middle) and batt. 2 (right)
Line 2: Selected charge/discharge program. The "+" und "-" signs in front/behind of the program info shows the polarity of the milli-amp-hours listed below (-> charge or discharge quantities).
Line 3-7: Column 1: Number of the cycle in this line.
Column 2: All charge or discharge quantities.
Column 3: Charge quantity of battery 1 and (below) the inner resistance of battery pack 1 and 2 inclusively all connectors, leads and charge leads.

<info> (pressed again) -> Fig. 23.6

Device state information
The numerical values in the lines 5, 6 and 7 are refreshed every second.

<info> (pressed again) -> back to Fig. 23.3 or 23.5 - depends on the curve-screen which was shown before <info> was pressed the first time.

Power-On screen Fig. 23.1

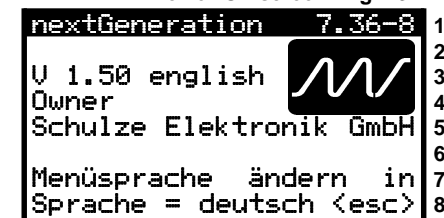

Changing language screen Fig. 23.2

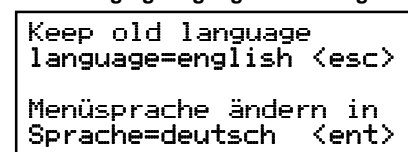

Battery 1 curve screen Fig. 23.3

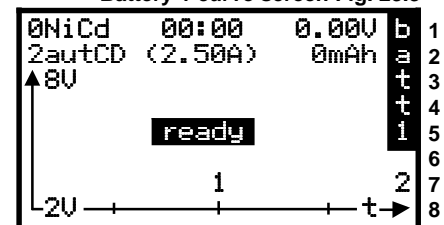

State info 1 (battery 1 & 2) Fig. 23.5

state:	b1charg.	.ready
progr	+auto2CD-	fix_C
cycl1	2483	2348
cycl2	123	0
		RiB1=
		317mΩ
		RiB2=
		0mΩ
capac.[mAh] batt1 batt2		

State info 2 (charger) Fig. 23.6

State info	nextGen.
Dev.Type:	next 7.36-8
Software Vers:	1.50
Device Number:	333
Input Voltage:	13.20V
Imp.Curr.Draw:	5.30A
TakenCapacity:	1.61Ah
Schulze Elektronik GmbH	

Fig. 23.7 Curve screen battery 1

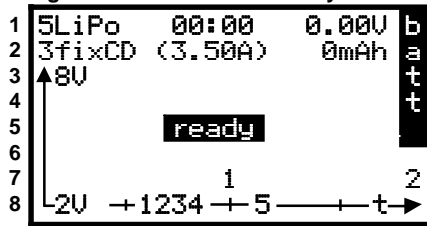

Fig. 23.8 Parameter screen battery 1

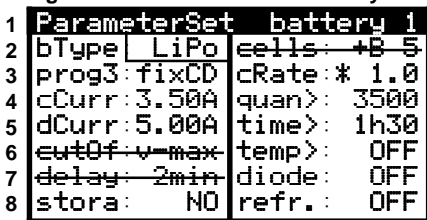

Fig. 23.9 Curve screen battery 2

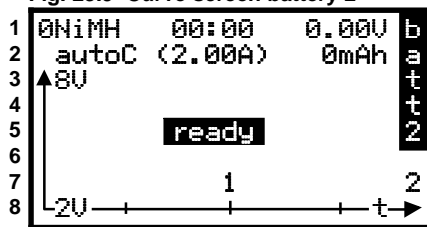
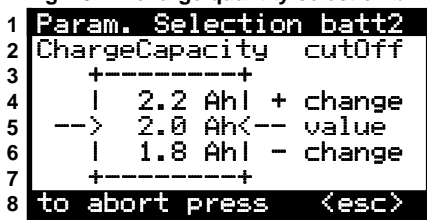

Fig. 23.10 Parameter screen battery 2



Fig. 23.11 charge quantity selection b.2



On the **curve-screen of battery 1** (Fig. 23.7) you see: In the first two lines of **fig. 23.7** the most important parameters of those parameters are displayed which had been selected in the screen showed below (Fig. 23.8).

A push on

<1> changes to the battery 1 parameter screen (fig. 23.8). If you press

<1> again, the screen changes back to fig. 23.7.

Hint re fig. 23.7:

On the left side of the line 1 the cell count (5) of the LiPo battery pack, in line 2 the selected program (fixCD) is displayed with the selected cycle count (3) in front of the program type. If a balancing cable is connected to the one row balancing socket then the balancing display (1234 and 5) appears at the bottom of the screen. The "ready" display does not go out as long as the charging cable is not plugged in. (**Hint:** Active balancers are shown in reverse video e.g. 12345). Because of the connected balancing cable the correct cell count is known and displayed -> which can not be changed any longer manually in the parameter screen. For this reason the cell count is crossed out in fig. 23.8! When a 3.2 Ah battery with a correctly configured Schulze balancing cable would be connected, the current display of 3.50 A would change the current which is given by the resistor value (3200 Ohm -> 3.2 A) multiplied by the selected C-rate (in this case 1.0!). These current value is not crossed out so that you can choose another current manually.

If the **curve screen of battery 2** (Fig. 23.9) a push on <2> changes to **fig. 23.10**, the **parameter screen of battery 2**. If you press again key

<2>, the screen changes back to **23.9** (curve screen).

Hint:

You also can press <1> and <2> alternately. Depending on the screen which is just displayed, the screens alternate between battery 1 <-> 2 curve screens or between battery 1 <-> 2 parameter screens.

If you press <enter> when the cursorbox in the parameter screen **fig. 23.10** is placed beside „quan>“ and the parameter „value“ in fig. 23.13 is selected to „tabular“ then the **fig. 23.11** appears. Otherwise the parameter screen with the +/- column cursor opens (**fig. 23.16** on the next page).

After having pressed

<par> the first of two device parameter sets is shown

fig. 23.12. following parameters can be selected:

- 23.12.2 le: external fan off/on (*)
- 23.12.3 le: external "full"-light (off/flashing/on) (*)
- 23.12.4 le: "full"-buzzer off/on.
- 23.12.5 le: Display background illumination off/on.
- 23.12.6 le: Charge quantity limit is also valid for discharging (Coupling off/on)
- 23.12.7 le: Changing owners name (see fig. 23.15)
- 23.12.2 ri: max. primary current (supply current)
- 23.12.3 ri: max. charge power
- 23.12.4 ri: under voltage warning limit car battery
- 23.12.5 ri: Cut-off temperature limit for the external temperature sensor (*). **Hint:** The sensor has to be activated by assigning it to a battery output.
- 23.12.7 ri: Changing the pass word to enable the change of the owners name (see fig. 23.15).

Another push on <par> leads to **fig. 23.13**.

23.13.2 le: Value selection via table (Fig. 23.11-tabular) or numerical (digit by digit 3 modes - Fig. 23.16):

nuStrict: Values between 0-9 can be selected. nuAround: 0 follows 9 or the other way round. numCarry: neighbouring digits are also affected at a run over of a digit (9->0 or 0->9).

Hint: When single digits are changed and the result is an under- or overflow of the limit of the complete value then the value is set to the max. or min. limit. **Hint:** Only long tables can be adjusted digit by digit.

23.13.3 le: Charger starts working after connecting the battery or starts manually after pressing the <+> key.

23.13.4 le: The balancing circuit works at „automat.“ with sliding precision: the higher the cell voltage the closer the voltage deviation of the cells in the pack OR fixed values between 4 mV to 20 mV OR "OFF" (no balancing => only voltage measuring) are allowed.

23.13.5/6/7 le: Fine tuning of the Li-discharge voltage limit (see also **chapter 21.11.5**).

23.13.2 ri: Menu narrow ("small", fig. 23.13, all parameters at a glance or "wide" (Fig. 23.14). This menu changes automatically when reaching the first/ last value or after pressing <1> or <r>.

23.13.3 ri: Resetting the complete device and battery parameter sets to standard values (does not affect the values of the clients setups).

23.13.4 ri: Resetting of the capacity display of the car battery which is shown on the info screen **fig. 23.6**.

23.13.5/6/7 ri: Fine tuning of the Li-charge voltage limit.

Fig. 23.15: Description see **chapter 16.10**.

Fig. 23.16: +/- cursor can be moved by pressing <1> and <r>. Leading "zeros" show the possible digit count.

(*) NextConn module necessary!

Device parameter screen 1 Fig. 23.12



Device parameter screen 2 Fig. 23.13

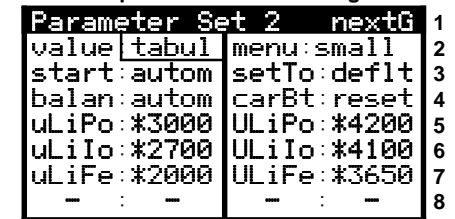

Dev. parameter screen 2 wide Fig. 23.14

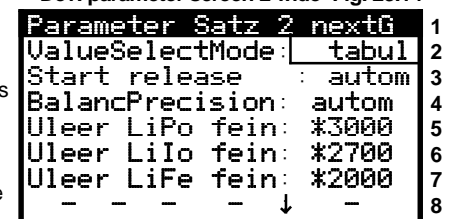

Name selection screen Fig. 23.15

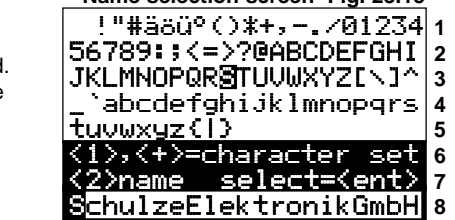

Charge quantity selection b.2 Fig. 23.16

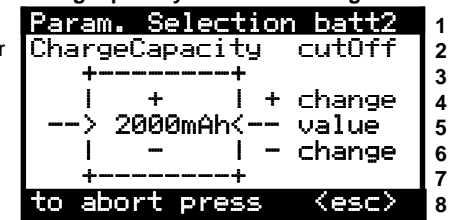

24 Standard ready-made configurations of version 8

For your own configurations space for 14 setups are available - which can be assigned alternatively from the battery outputs 1 or 2. If you are in the menu for battery 1 you are not able to read setups written by the battery 2 menu (or the other way round - the name of the configuration is crossed out).

We recommend to store setups for the battery 2 output from "behind" i.e. beginning with the last (highest) setup number.

If you have your own ideas about configuration names, or if you wish to alter the order of the configurations, you can certainly do this exactly as you wish within the limits of the software's facilities. For example, to copy a particular configuration to a different number, simply read in the configuration with the old number, then store it under the new number. Only the name has to be altered.

#	Outp.	Name	B.Type	Program	cCurr [mA]	dCurr	Quant.	Time	CutOff
1	1	Po-C3Ah7	Li-Po	fix_C	3700	(3700)	4000	90	v-max
2	1	Po-C5Ah0	Li-Po	fix_C	5000	(5000)	5500	90	v-max
3	1	Po-CD3A2	Li-Po	fix_C	3200	(3200)	3600	90	v-max
4	1	MH-C3Ah6	Ni-MH	autoC	max.	(max.)	5000	120	sensitive
5	1	MH-D3Ah6	Ni-MH	autoD	(max.)	max.	(5000)	(120)	(sensit.)
6	1	MH-CD3A6	Ni-MH	autoCD	max.	max.	5000	120	sensitive
7	1	Cd-C2Ah4	Ni-Cd	autoC	max.	(max.)	2800	60	normal
8	1	Cd-D2Ah4	Ni-Cd	autoD	(max.)	max.	(2800)	(60)	(normal)
9	1	Pb-C7Ah0	Lead	fix_C	2500	(2500)	7000	300	v-max
10	2	Po-C3Ah2	Li-Po	fix_C	3000	-	3600	100	v-max
11	2	Po-C2Ah0	Li-Po	fix_C	2000	-	2400	90	v-max
12	2	Fe-C1Ah2	Li-Po	fix_C	1200	-	1600	90	v-max
13	2	MH-C1Ah2	Ni-MH	autoC	3000	-	1800	120	v-max
14	2	Cd-C1Ah2	Ni-Cd	autoC	3000	-	1800	60	v-max

Addition: All CombinationCycles, C-Rates, CellCounts (except nickel batteries) = 1;

Hint: Values in parenthesis are set but not used.

25 Standard setup charge-/discharge programs

Menu	output 1	output 2
Battery type ("bType")	NiCd	NiCd
Charge/discharge program ("prog.")	autoC	autoC
Charge current ("cCurr")	3.00 A	1.50 A
Discharge current ("dCurr")	3.00 A	-
Cut-off mode ("cutOf")	normal	normal
Cut-off delay ("delay")	1 minute	1 minute
Cell count ("cells")	0	0
Charge quantity limit ("quan>")	4000 mAh	2000 mAh
Charge time limit ("time>")	60 minutes	60 minutes
Temperature cut off limit ("temp>")	OFF	OFF
Discharge protection Diode ("diode")	NO	NO
Refresh (short discharge pulses) ("refr.")	OFF	-

Charger parameters:

Car battery minimum voltage	11.2 V
Temperature	60 °C
Current / power (depends on type of charger)	maximum
Full / Empty Light Output	Flashing light

Other parameters: All CombinationCycles, C-Rates, CellCounts (except nickel batteries) = 1; lithium-full/empty-limits as stated in **chapter 4** or shown in **Fig. 7.5.2**.

26 Data format PC interface

Data transfer rate: 9600 Baud, No Parity, 1 Stop-Bit, 1 Start-Bit

Data block - format without single cell voltage output (without balancer):

P: sssss:uuuu:iiiiVSttt (ASCII)

Data block - format with single cell voltage output (balancer cable is connected):

P: sssss:uuuu:iiiiVSttt;uuuZ1;uuuZ2;uuuZ3;uuuZ4;uuuZ5;uuuZ6;uuuZ7;uuuZ8;

Legend:

P	Pack-Output-No.
:	Separation sign
sssss	Time in seconds
:	Separation sign
uuuuu	Battery voltage in millivolt
:	Separation sign
iiii	Current in milliampere
V[:,-]	Charge/discharge indicator
S[l,L,E,P,v...]	Charge-/Discharge program status
ttt[-, ,0..9]	Temperature (***)
;	Separation sign
uuuZ1	Voltage of cell 1 in millivolt
;	Separation sign
uuuZ2	Voltage of cell 2 in millivolt
;	Separation sign
...	
;	Separation sign
uuuZ7 (or uuuZ11)	Voltage of cell 7/11* in millivolt
;	Separation sign
uuuZ8 (or uuuZ12)	Voltage of cell 8/12* in millivolt
;	Separation sign

Hints:

(*) at -5 items Z6, Z7, Z8 is 0 (zero); max. 8 at -8 items; max. 12 at -12 items

Not existing cells are displayed as „ 0“.

No leading zeros are displayed.

Commentary lines starts (as a rule) with a leading „*“

Commentary line: * **PackOutputNo UsedProgram CellCount BatteryType**

Re cell count:

Calculated cell count at nickel-batteries. Selected cell count at lead- and lithium-batteries.

(**) The display of the temperature:

When a temperature sensor is connected (nextConn-printed circuit board necessary) the temperature of the connected temperature sensor is displayed in the format shown above - and is also shown in the LC-display of the **nextGen**.

Otherwise the internal device temperature (measured near the cooling fins) is displayed.

The format changed into: tti, i.e. two temperature digits followed by an „i“ (means: „internal temperature“).

27 PC interface connector 5V-SIO, look on the pins of the plug



1 = Transmit*, 2 = Receive*, 3 = + 5V**, 4 = GND**
 (*) Denomination at the internal µP; (**) via low-ohm resistor

28 Balancing connectors and measuring inputs

- The balancing connectors are exclusively assigned to the battery 1 output.
 - It is important that only one battery is connected i.e. it is allowed to use only one of the three balancing connectors at the same time.
 - Avoid short circuits between the open pins when a battery is connected to one of the connectors!
- > In that case inadmissible high cross currents between the connectors would damage the printed circuit board.



28.1 Pin assignment of the BalCab10

Pin assignment of the 10-pin balancing cable of the *Schulze BalCab10-Set* or of the *BalCab10-Verl* for the *Schulze LiPoPerfekt* battery packs up to 4 cells.

Pin assignment *BalCab10* e.g. on the balancer plug of the *LiPoCard*

Cable colour	Assignment	Pin	Pin Assignment	Cable colour
brown	battery +	10	9 '+' batt. ('+' last cell: 1,2,3 or 4)	red
orange	cell type	8	7 '+' cell 3 (no connect at 2s pack)	yellow
green	charge curr.(2)	6	5 '+' cell 2 (no connect at 1s pack)	blue
lilac	charge curr.(1)	4	4 '+' cell 1	grey
white	battery -	2	1 '-' cell 1 (battery -)	black

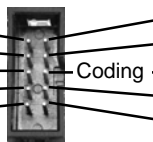

Hint:
 A detailed description of the pinout and the mounting instructions are enclosed in the balancer cable kits (-Set).



28.1.1 Schulze BalCab10-Set
 Balancer cable kit for fitting to existing battery packs.
 10-pin, for two to four cells in series.



28.1.2 BalCab10-Verl
 Ready-made balancer cable for connecting *Schulze LiPoPerfekt* battery packs.
 10-pin, for two to four cells in series.

The principle of connection of Schulze Balancers

(cell arrangement as the storeys in a high-rise building)

- + cell 8 (eighth storey) = + battery
- + cell 7 (seventh storey) = - cell 8
- + cell 6 (sixth storey) = - cell 7
- + cell 5 (fifth storey) = - cell 6
- + cell 4 (fourth storey) = - cell 5
- + cell 3 (third storey) = - cell 4
- + cell 2 (second storey) = - cell 3
- + cell 1 (first storey) = - cell 2
- cell 1 (ground floor) = earth = - battery

28.2 Pin assignment of the BalCab20

Pin assignment of the 20-pin balancing cable of the *Schulze BalCab20-Set* or of the *BalCab20-Verl* for the *Schulze LiPoPerfekt* battery packs up to 14 cells.

Cable colour	Assignment	Pin	Pin Assignment	Cable colour
brown	battery - (-cell1)	20	19 battery +	red
orange	cell type	18	17 charge curr.(1)	yellow
green	charge curr.(2)	16	15 '+' 14 resp. batt.+	blue
lilac	'+' cell 13	14	13 '+' cell 12	grey
white	'+' cell 11	12	11 '+' cell 10	black
brown	'+' cell 9	10	9 '+' cell 8	red
orange	'+' cell 7	8	7 '+' cell 6	yellow
green	'+' cell 5	6	5 '+' cell 4	blue
lilac	'+' cell 3	4	3 '+' cell 2	grey
white	'+' cell 1	2	1 '-' cell 1 (battery -)	black

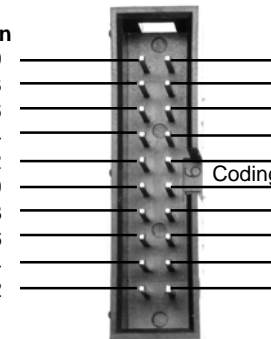

Hint:
 A detailed description of the pinout and the mounting instructions are enclosed in the balancer cable kits (-Set).



28.2.1 BalCab20-Set
 Balancer cable kit for fitting to existing battery packs.
 20-pin, for two to fourteen cells in series.



28.2.2 BalCab20-Verl
 Ready-made balancer cable for connecting *Schulze LiPoPerfekt* battery packs.
 20-pin, for two to fourteen cells in series.

28.3 Pin assignment of the 9-pin universal socket

Balancing In-/Output for 2-5 cells (next 6.30-5) or for 2-8 cells (next 7.36-8 or 10.36-8).
Voltage measuring inputs for 1-8 cells on all devices.

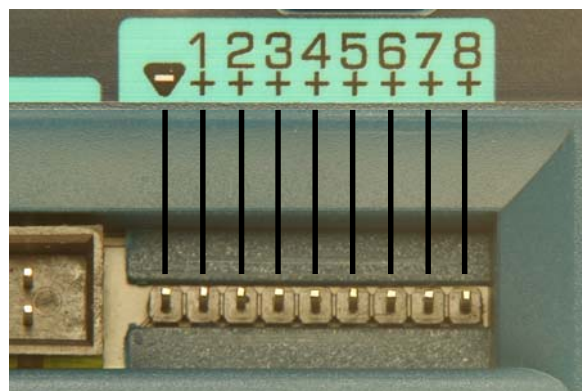

- '+ 8' = +cell 8* and measuring input 8
- '+ 7' = +cell 7* and measuring input 7
- '+ 6' = +cell 6* and measuring input 6
- '+ 5' = +cell 5 and measuring input 5
- '+ 4' = +cell 4 and measuring input 4
- '+ 3' = +cell 3 and measuring input 3
- '+ 2' = +cell 2 and measuring input 2
- '+ 1' = +cell 1 and measuring input 1

'-' cell 1 (neg. battery, GND) = Pin 1 of the (2,54 mm pitch) pin row.

[*] balancing not available for cell 6-8 in the **nextGen 6.30-5**

29 Additional sockets on the right side

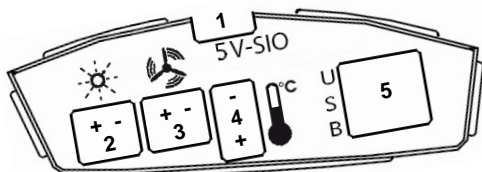

- 1: 5V-SIO (standard)%
 - 2: Flashing light output (only with nextConn module)
 - 3: External fan output (nextConn module only)
 - 4: Temperature sensor input (nextConn module only)
 - 5: USB in-/output (only with nextConn module)%
- (%) Do not connect or use 1 and 5 at the same time!

30 Specifications

Common:

All data given is based on a car battery voltage of 12.5 volts
 Recommended car battery 12V / bigger than 90 Ah, minimum 12 V / 63 Ah
 Tolerances @ battery 1 currents: typical 5%; max. about 15% resp. 250mA (larger value counts)
 Tolerances @ battery 2 currents: typical 5%; max. about 10% resp. 100mA (larger value counts)

	next 6.30-5	next 7.36-8/-12	next 10.36-8/-12
Weight about	760 g	810 g	830 g
Dimensions (w*d*h) about	161 * 170 * 66 mm	161 * 170 * 66 mm	161 * 170 * 66 mm
Supply voltage	10,0 - 25,0 V	10,0 - 25,0 V	10,0 - 15,0 V
Under-voltage warning adjustable ~	11,6 - 10,4 V	11,6 - 10,4 V	11,6 - 10,4 V
- cut-off: volts lower ~	0,5 V	0,5 V	0,5 V
Supply current @12,0/13,8 V up to about	18/16 A	26/23 A	28/25 A
Max. input power up to about	220 W	315 W	340 W
Idle current about	100 mA	100 mA	100 mA
+ display illumination (disconnectable) about	50 mA	50 mA	50 mA
Fan (internal):	12V/1,1 W/32 dBa	12V/1,1 W/32 dBa	12V/7W/55 dBa
Trickle currents Ni-Cd	pulses	pulses	pulses
Trickle currents other battery types	none	none	none

Additional connection terminals

Standard:	5 V-SIO	5 V-SIO	5 V-SIO
Numb. of cell voltage measuring inputs****	8	8 / 12	8 / 12

Optional available for: next 6.30-5, next 7.36-x eco, next 10.36-x eco;
 standard at: next 6.30-5 plus, next 7.36-x, next 10.36-x:

- 1) USB connector Standard B
- 2) Temperature sensor Sensor included ready for use
Resolution: 1 °C
- 3) Flashing light connector + cable cable about 2 m, flashing light not included
Voltage: Supply voltage of the charger, max. current 2,0*** A
- 4) Fan connector + cable cable about 2 m, fan not included
Voltage: Supply voltage of the charger, max. current 2,0*** A

Remarks

* Charging is possible from 1 cell and higher. However the „Delta-Peak“ cut-off automatic has to do a hard job at low cell counts because the peak voltage of 1...3 cells is not very high.

** Input voltage of 13,8 volts or higher.

*** Flashing light current plus fan current added together = 3 amps max. current.

**** via balancing connectors

Battery 1 output	next 6.30-5	next 7.36-8/-12	next 10.36-8/-12
Ni-Cd/Ni-MH batteries:			
Cell count (@ 1.65V / cell)	1* - 30 cells	1* - 36 cells	1* - 36 cells
max. battery capacity Ni-Cd	0.1 - 3 Ah	0.1 - 3.5 Ah	0.1 - 5 Ah
max. battery capacity Ni-MH	0.1 - 6 Ah	0.1 - 7 Ah	0.1 - 10 Ah
Charge currents	0.1 - 6 A	0.1 - 7 A	0.1 - 10 A
Charge power @ 12V about	150 W	240 W	240 W
@ 1-24 V (~1-15 cells) about	6.0 A	7.0 A	10.0 A
@ 30 V (~18 cells) about	5.0 A	7.0 A	8.0 A
@ 40 V (~24 cells) about	3.7 A	6.0 A	6.0 A
@ 45 V (~27 cells) about	3.3 A	5.3 A	5.3 A
@ 50 V (~30 cells) about	3.0 A	4.8 A	4.8 A
@ 60 V (~36 cells) about	-- A	4.0 A	4.0 A
Lead/Li-Fe, Li-Ion, Li-Po batts.:			
Power balancing circuits	5	8 or 12	8 or 12
Cell count lead batteries	1 - 19 cells	1 - 23 cells	1 - 23 cells
Cell count Li-Fe batteries	1 - 13 cells	1 - 16 cells	1 - 16 cells
Cell count Li-Ion batteries	1 - 12 cells	1 - 14 cells	1 - 14 cells
Cell count Li-Po batteries	1 - 12 cells	1 - 14 cells	1 - 14 cells
max. battery capacity	0.1 - unlimited Ah	0.1 - unlimited Ah	0.1 - unlimited Ah
Discharge circuit:			
Cell count (@ 1.30V / cell)	1 - 33 cells	1 - 40 cells	1 - 40 cells
Discharge currents	0.1 - 6 A	0.1 - 7 A	0.1 - 10 A
Discharge power into the flat car battery about	150 W	240 W	240 W
@ 1-24 V (~1-18 cells) about	6.0 A	7.0 A	10.0 A
@ 32 V (~24 cells) about	4.7 A	7.0 A	7.5 A
@ 36 V (~27 cells) about	4.2 A	6.7 A	6.7 A
@ 40 V (~30 cells) about	3.7 A	6.0 A	6.0 A
@ 49 V (~36 cells) about	-- A	4.9 A	4.9 A
@ 54 V (~40 cells) about	-- A	4.4 A	4.4 A
max. dissipation power of the integrated discharge load => Discharge power @ discharge on a power supply or fully charged car battery up to about			
	50 W	50 W	100 W
Battery 2 output	next 6.30-5	next 7.36-8/-12	next 10.36-8/-12
Ni-Cd/Ni-MH batteries:			
Cell count (@ 1.5 V / cell)	1* - 6 cells	1* - 6 cells	1* - 6 cells
Capacity Ni-Cd batteries about	0.1 - 1.5 Ah	0.1 - 1.5 Ah	0.1 - 2.5 Ah
Capacity Ni-MH batteries about	0.1 - 3.0 Ah	0.1 - 3.0 Ah	0.1 - 5.0 Ah
Charge current about	100 - 3000 mA	100 - 3000 mA	100 - 5000 mA
Lead/Li-Fe, Li-Ion, Li-Po batts.:			
Cell count lead batteries	1 - 4/5** cells	1 - 4/5** cells	1 - 4/5** cells
Cell count Li-Fe batteries	1 - 3 cells	1-3 cells	1 - 3 cells
Cell count Li-Ion batteries	1 - 2/3** cells	1 - 2/3** cells	1 - 2/3** cells
Cell count Li-Po batteries	1 - 2/3** cells	1 - 2/3** cells	1 - 2/3** cells
max. battery capacity	0.1 - unlimited Ah	0.1 - unlimited Ah	0.1 - unlimited Ah

31 Installing the nextConn module

The *next 6.30-5* is supplied as standard without the *nextConn* module, but the module can very easily be installed if and when required, converting the unit into the *next 6.30-5 plus*.

31.1 Opening the case

Undo the six cross-point screws (1 – 6) and remove the bottom case section.

31.2 Installing the NextConn module and the side panel insert

31.2.1 Remove the side panel (8) and replace it with the new, perforated panel. You may find that the side panel comes away together with the bottom case section.

31.2.2 Locate the ten holes in the smooth underside of the *nextConn* module (9) and position them directly over the ten connector pins (7) mounted on the large base circuit board. Don't use force! The *nextConn* module will automatically (!) fall into place on the base circuit board if correctly positioned. Check that the two nylon screws engage in the corresponding holes in the base circuit board.

31.3 Pressing the nextConn module into place

Press the *nextConn* module down firmly as far as it will go, to ensure that the connectors make good contact. The tips of the connector pins (7) must be exposed at the top of the ten-pin socket (10).

31.4 Closing the case

Position the bottom case section accurately on the top case section, taking care to engage the side panels correctly. Re-fit the screws (1 – 6); take care not to over-tighten them.

Note: the *nextConn* module is not screwed to the base circuit board. Nevertheless, it is held in place securely by the moulded-in supports (13 – 16) and the two nylon screws (11 – 12) when the case components are screwed together.

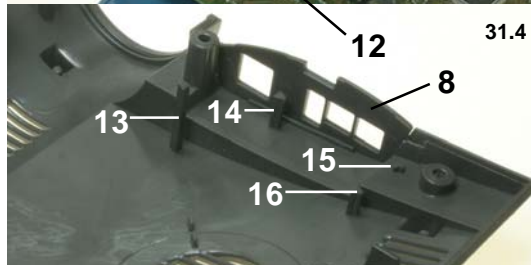
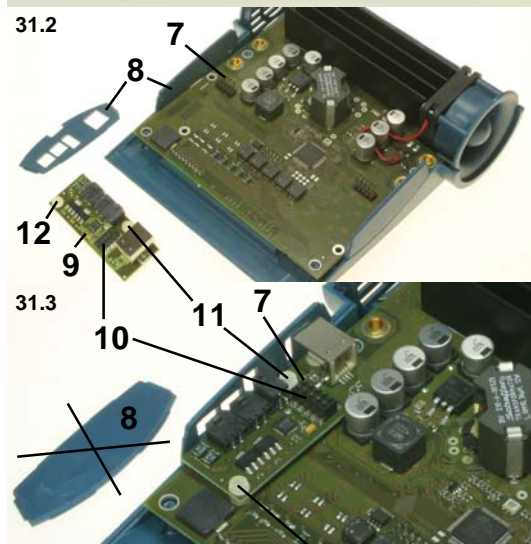
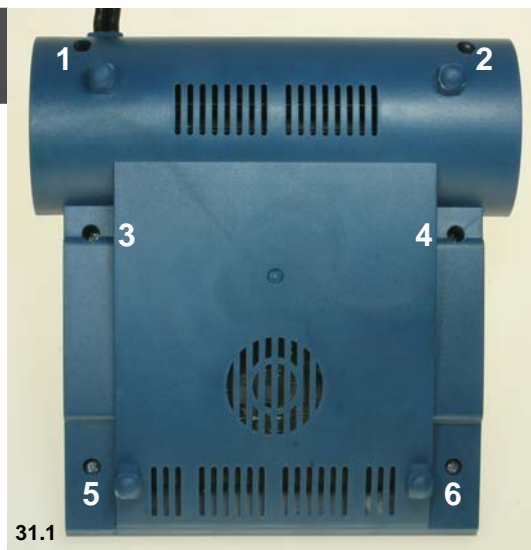

32 Installation of the USB-driver on the PC

If you like to display the online-charge/discharge-data (which are available on the USB-port of chargers, balancers or adapters) via „winsoft“ or „Akkusoft“ as well as installing a firmware update then you have to install the „USB \leftrightarrow COM“ driver on your PC first (available on our homepage or on our USB-stick).

32.1.1 Windows operating systems initially ask the user at the moment when you have connected the USB-port of our USB-adapters or chargers with the USB-slot on your computer.

If you had aborted the hardware installation assistant you can start it again by a right-click on MyComputer ("Arbeitsplatz" in german) -> Properties, -> Hardware, -> Device Manager, -> Other devices, -> FT232R USB UART then right click on -> update driver and start again (or similar text).

It is not necessary that the charger or our USB-adapter is connected to any power supply - it is powered via the USB-cable.

32.1.2 Set the desired file-path to the downloaded file or the file path on the USB-stick (corresponding to your type of operating system).

32.1.3 When the driver is successfully installed then you have to look on which COM port the operating system has installed your USB-device.

You can establish the number of the COM port occupied by the driver by right-clicking on the workplace symbol of your PC; click or double-click on Properties, Hardware, Device Manager, Ports (COM and LPT).

You will find a COM port with the name "USB Serial Port". Windows normally installs the device on "COM3" or higher.

Note:

This connection is only displayed when the charger or our USB-adapter is connected to the USB port of the PC!

VERY IMPORTANT:

If you use more than one USB-device then the driver will install **ONE** COMxx port for **EACH** of your different devices - even when not all devices are connected at the same time.

Reason: Every USB to serial converter chip has its own device number, so the connections are also assigned to different COM-ports - **which are always the same for each device on one PC!**

For this reason it is possible that all USB-converters can be used at the same time and also e.g. the charger No. 1 always is assigned to COM3, the charger No.2 is always assigned to COM4 and the USB-adapt-alpha always uses the COM5 port - even when not all devices are connected at the same time.

These proceedings are not specific for the "winsoft" or "Akkusoft" or any connected charger, but is specific for installing a driver on the Windows operating system.

32.2 Setting the COM port in the "Akkusoft" or "winsoft" analysis program.

32.2.1 Open "Akkusoft" or "winsoft". Open the pull-down menu entitled "Connection", then click on "Properties". Select the port identified under 1.3, then click on OK.

32.2.2 Checking the function of the COM interface (in the analysis program).

Click on "Info", then on "Online Info". An information window opens, displaying the communication between the charger (or also a Schulze balancer) and the PC.

Now connect the charger to the power supply, or – if you have already done that – connect a battery to the charger.

The interface data appears in the "Online Data" window mentioned above.

32.2.3 If a) you have connected a nextGeneration charger to the power supply and the USB-adapt-uni (at the non-USB types), and b) you have not yet connected a battery, and c) the Online Data window of "Akkusoft" (not available at the "winsoft") is set to "Terminal Mode", then you can very easily check the interface in both directions using the following method:

Type a few letters or numerals on your PC keyboard, and the text should then appear in the "Online Data" window.

32.3 Firmware update

When this test (see 2.3) was successful then you also can upgrade the firmware via this USB-Link. Click on "Tools" and then "FirmwareUpdate" and follow the instructions on the update-screens.

Additional information: <http://www.ftdichip.com/Documents/InstallGuides.htm>

TS-Trouble Shooting

Dear customer,

If your charger appears not to work as you expect it to, please run through the measures outlined below step by step before assuming that it is faulty.

Only if you have completed all these checks, and the problem is still present, ring on our hotline for technical advice. Even better, fill in the service questionnaire (next page) and send it by e-mail or fax to us. We will then e-mail you back with advice.

From long years of experience with our battery chargers we know that most problems do not arise if the points listed below are followed to the letter.

If we receive your charger but can find no fault with it ("no fault found") - which usually means that the measures described below have been ignored - please note once again that we incur costs in checking the unit, and that those costs are payable by you even if the charger is within the warranty period.

1. Connect the charger to a fully charged car battery with a capacity of at least 60 Ah. Do not use a mains-powered Power Supply Unit!
2. For the power supply to the charger use only the original cables and terminal clips. Connectors such as wander plugs, car cigar lighter plugs etc. are not suitable! If you have made changes, kindly restore the original cables and clips. Take care to produce sound soldered joints - no "solder blobs" or dry joints, please!
3. Charge cables for all batteries should have a conductor cross-section of 2.5 sq mm. The charger's automatic current setting circuitry is only capable of setting a suitable (i.e. high) charge current for your battery if the cable is of this cross-section. Give the automatic circuit a fair chance!
4. Just as important as the charge cables are the connectors attached to them. Use quality 4 mm gold-contact connectors at the charger end.

Attention - faulty designs:

When 3.5 or 4 mm plugs(male) can be turned in the socket like a bearing, then the spring lamella has an intermittent contact to the plugs core! The spring is/can not be pressed to the centre pin.

Don't use expensive wander plugs too. The wires will often loose their force (will be bended) after a short time.

Your flight packs should already be fitted with gold-contact connectors. Sheet metal connectors are completely unsuitable as their transfer resistance is high and they are prone to intermittent contact. **Furthermore** be sure that your cables are well soldered to the plugs and sockets. Do not fasten with screws.

5. If you observe Points 3) and 4) and connect a discharged battery to the charger, the fully automatic charge mode should set a current of at least 1C, usually as much as 2C, after about 5 - 10 min-utes. If this is not the case, then the internal resistance of the battery is probably excessive. In short, your battery has "had it", or is not suitable for rapid-charging.
6. Ensure that there are no defective cells in the battery pack. Bad cells usually heat up early in the charge, and then cause the charger to switch off prematurely, and/or to set too low a charge current in automatic mode.
7. If a 2-3 hour charge time is exceeded in automatic mode, then something is wrong with your charge cable, your connectors or your battery. Perhaps too small a cross-section in the charge cable? Connectors not good-quality gold-contact types? Dry solder joints? Battery ready for the bin, or not designed for rapid-charging?
Establish the reason! Attempting to alter the 3/4-hour time limit is not the way forward, as in most cases a charge period of one hour already indicates that something is amiss. After 5 - 10 minutes the automatic circuitry should have set a charge current of at least 1C!
8. Have you read the information in Chapter 2 (General remarks and precautions) of the operating instructions and observed the recommendations?

SQ-Service Questionnaire

Your Address:

and

To: Schulze Elektronik GmbH

Fax-No. +49-6150-1306-99

or to: hotline@schulze-elektronik-gmbh.com

Telephone No.:

eMail Address:

Please complete every section. If a fault arises please return this form with the unit!

Battery:	Your Information	Example
Purpose (Transmitter, receiver, flight pack)		Transmitter
Manufacturer		Sanyo
No. of cells / voltage		8 cells/9.6 volts
Capacity		1700 mAh
Type		1700SCE
Cells soldered or clipped		welded
Charge cable connector		Barrel
Charge cable:		Original<manufact>
Length		0,5 m
Cross-section		0,14 sq-mm
Charger connector		Wander plug
Power supply:		
Fault with mains PSU power:		yes
- PSU type		NT-16A
- Output voltage		13.5 V
- Maximum output current		16 A
Fault with car battery power:		no
- Nominal capacity, car battery		45 Ah
Charger:		
Type		next 7.36-8
Software version (read out display after power on)		V 1.03
Charge output used		battery 1
Charge program/Current if "fixed" selected		autoC or x,xx A
(Automatic mode:) max. charge current		0.83A
(Automatic mode:) charge current at fault		0.25A
Duration of charge		133 min
Battery temperature at termination		30°C
Error message		# 41

Description of fault: Charge output 1, 2 all in use?