

15 Specifications

Key to product summary *future-I, -xl, -xxl* in section 16

Weight	Specification is excluding / including power cables		
Current rating	Nominal current / maximum current The excess current level lies above the maximum current value for each unit. The nominal current value is the continuous current at full throttle at which the future can be operated when connected to a 3 Ah battery without forced cooling. The nominal current value actually achieved may vary in either direction with different types of motor, rotational speeds and cell counts.		
Throttle, brake	Internal resistance of the MOSFETs, based on data sheet values (25°C / 10 V gate voltage). At 125°C the resistance is about 40% higher. For this reason you should always provide an effective flow of cooling air over the future to prevent it getting too hot.		
Receiver input	Voltage: 4.5 V ... 8.4 V (2s LiPo),	Pulse height: 2.8 V ... 5.0 V	
- Pulse times	Pulse width: 0.8 ms ... 2.5 ms,	Cycle time: 4 ms (HRS mode) ... 30 ms	
Rotational speed	The rotational speed stated above is the limit value for a 2-pole motor (...P2). The following division factors apply: P4= /2; P6= /3; P8= /4; P10= /5.		
Part-load-switching frequency:	7 - 35.2 kHz: future controllers make measurements at the motor when the controller is connected to the battery and then sets the fitting frequency fully automatically		
Soft-start	The soft-start feature on throttle and brake is different for all applications (aircraft / helicopter / boat / car)		
Over temperature electronics:	Limit is at about 110 °C		
Over temperature motor:	Limit is at about 100 °C		
Over temperature battery:	Limit is at about 70 °C		
Logging time about	150 minutes	@ resolution	0 = 50 milliseconds
	50 hours	@ resolution	9 = 1 second
Transmission time	total memory (4 MB); using the Akkusoft on the PC; „Automatic Window Graph“ on or off: Transmission format		
	5 V-SIO / RS232 (9600 Bd): about	ASCII	SHORT (on) SHORT (off)
	USB („slow“ PC): about	1 h 30 min	1 h 20 5 min
	USB („fast“ PC): about	30 min	20 min 4 min

16 Product overview *future-I, -xl, -xxl*

Type	Current	Nickel	Lithium	Size	Weight	Cable	Throttle	Brake	Rot.Sp.	Remark
Unit -->	[A]	[cell count]		[mm]	[g]	[mm²]	[mΩ]	[mΩ]	[min⁻¹]	
24 / 8 cells										
<i>future-I-24.150WK</i>	150/200	10-24	3- 8	95+BR*65*21	124-156	4*4.0	2*0.7	0.7/3	240k	1 cool.tube
32 / 10 cells										
<i>future-I-32.115</i>	115/150	10-32	3-10	95+B*65*21	113-145	4*4.0	2*1.0	1.0/3	240k	
<i>future-I-32.115WK</i>	115/150	10-32	3-10	95+BR*65*21	124-156	4*4.0	2*1.0	1.0/3	240k	1 cool.tube
<i>future-xt-32.202WK*</i>	200/260	10-32	3-10	130+R*73*21	189-229	4*6.0	2*0.56	0.56/3	240k	1 cool.tube
40 / 14 cells										
<i>future-I-40.100</i>	100/133	10-40	3-14	95+B*65*21	113-133	2*6.0	2*1.5	1.5/3	240k	
<i>future-I-40.100WK</i>	100/133	10-40	3-14	95+BR*65*21	124-144	2*6.0	2*1.5	1.5/3	240k	1 cool.tube
<i>future-xt-40.161*</i>	160/210	10-40	3-14	130*73*29	181-213	4*4.0	2*0.9	0.9/3	240k	
<i>future-xt-40.161WK*</i>	160/210	10-40	3-14	130+R*73*29	203-235	4*4.0	2*0.9	0.9/3	240k	2 cool.tub.
<i>future-xxl-40.303K*</i>	300/400	12-40	4-14	161+B*100*38	520-560	4*6.0	2*0.75	0.75/3	240k	
<i>future-xxl-40.303WK*</i>	300/400	12-40	4-14	161+BR*100*34	590-630	4*6.0	2*0.75	0.75/3	240k	water cool-
<i>future-xxl-40.333K</i>	330/440	12-40	4-14	161+B*100*38	520-560	4*6.0	2*0.59	0.59/3	240k	
<i>future-xxl-40.333WK</i>	330/440	12-40	4-14	161+BR*100*34	590-630	4*6.0	2*0.59	0.59/3	240k	water cool-

Key to table above

+S Motor Sockets = plus about 12 mm
+T Cooling Tube(s) = plus two times about 15 mm

* The specifications of the predecessor types xl-32.200, xl-40.160, xxl-40.300 are equivalent to the data in the table.



future-I, xl, xxl

Power speed controller for brushless and sensorless motors

Operating instructions V 1

Date of issue: 23 JUN 2011



Wiring diagram *future-I* series

Illustration *future-I-32.115*



Key to illustration:

- b = brown
- r = red
- o = orange

- 1 Receiver cable, 3-pin:
- 2 Battery connection neg (-) . . black
- 3 Battery connectin pos. (+) . . red

Hint: If you are using the **future-I** with two parallel battery cables, these cables must run in pairs (+ and -) to two battery packs; the packs are then wired in parallel in order to achieve maximum current delivery capacity.

- 4 Motor connection* red **(Reverse use blue, black)**
- 5 Motor connection* white, yellow **(Reverse use white, yellow)**
- 6 Motor connection* blue, black **(Reverse use red)**
- 7 DIL switch to select the operating mode
- 8 BalCab20 plug balancing connector - Schulze BalCab20 compatible
- 9 5 V-SIO to read out logger data and for installing firmware upgrades
- 10 USB connector as 9). Not available on splash water protected types.
- 11 HALL input for positioning the airscrew and selecting Aerobatic mode.
- 12 Temperature input To connect the motor temperature sensor (Top of PCB)
- 13 Temperature input To connect the battery temperature sensor (Bottom of PCB)
- 14 Fixing holes please remove the heat shrinking tubers around the holes and mount the controller on shock absorbers in the fuselage.

(*) Please note the following guidelines, which apply when you are connecting the motor and reversing its direction of rotation:

- 1 The controller can be used with sensorless and sensor-controlled motors.
If your motor is sensor-controlled, the 5-pin connector is not used.
- 2.1 The three motor cables can be connected in any order.
- 2.2 To reverse the direction of rotation you have to swap over two of the three motor cables.

Wiring diagram future-xl series

Illustration future-xl-32.200 / 32.202 / 40.160 / 40.161 (WK)

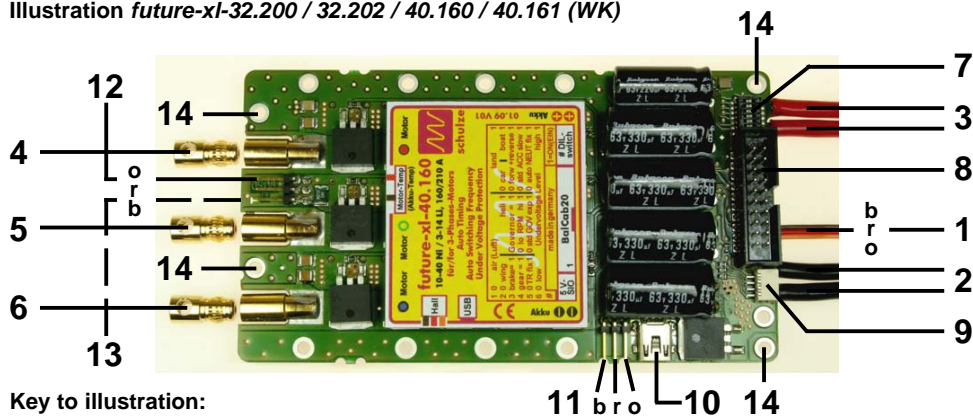

Key to illustration:

- b = brown
- r = red
- o = orange

- 1 Receiver cable, 3-pin:
- 2 Battery connection neg (-). . black
- 3 Battery connectin pos. (+). . red

Hint: If you are using the *future-xl* with two parallel battery cables, these cables must run in pairs (+ and -) to two battery packs; the packs are then wired in parallel in order to achieve maximum current delivery capacity.

- 4 Motor connection* red **(Reverse use blue, black)**
- 5 Motor connection* white, yellow **(Reverse use white, yellow)**
- 6 Motor connection* blue, black **(Reverse use red)**
- 7 DIL switch to select the operating mode
- 8 BalCab20 plug balancing connector - Schulze BalCab20 compatible
- 9 5 V-SIO to read out logger data and for installing firmware upgrades
- 10 USB connector as 9). Not available on splash water protected types.
- 11 HALL input for positioning the airscrew and selecting Aerobatic mode.
- 12 Temperature input To connect the motor temperature sensor (Top of PCB)
- 13 Temperature input To connect the battery temperature sensor (Bottom of PCB)
- 14 Fixing holes please remove the heat shrinking tubers around the holes and mount the controller on shock absorbers in the fuselage.

(*) Please note the following guidelines, which apply when you are connecting the motor and reversing its direction of rotation:

- 1 The controller can be used with sensorless and sensor-controlled motors.
If your motor is sensor-controlled, the 5-pin connector is not used.
- 2.1 The three motor cables can be connected in any order.
- 2.2 To reverse the direction of rotation you have to swap over two of the three motor cables.

14 Legal matters

14.1 Warranty

All **Schulze devices** are carefully checked and tested before dispatch.
If you have a complaint, send the unit back to us with a clear description of the fault.
A message such as "doesn't work properly" or "software error" doesn't help us much!

For all supply of warranty services our Terms of Sale and Supply are applicable (see Schulze Homepage).

One further note:

If a problem arises with any schulze product, send it directly to us without interfering with it in any way.

Changes or extensions of the device can lead to additional costs if these impede or prevent services.

Non-suitable components will be replaced or build back to the delivered condition at the owners expense without any consultation.

This ensures that we can repair the unit quickly, pick up warranty faults without any dispute, and keep costs to a minimum.

You can also be sure that we will fit genuine replacement parts which will work properly in your unit. Unfortunately we have had bad experience with third-party Service Centres which claim technical competence. Note also that any out-side interference with our products invalidates the warranty. Incompetent attempts at repair can cause further damage. We often find it impossible to estimate the repair cost of devices in such condition, and in certain circumstances we are then obliged to decline to repair it altogether.

14.2 CE approval

All **Schulze devices** satisfy all relevant and mandatory EC directives:

These are the

EMF directive
additional changes

89/336/EWG: 3.May 1989 plus
up to 3. January 1994

The product has been tested to meet the following basic technical standards:

Interference radiation:

DIN EN 55014-1: 2003-09

Interference susceptibility:

DIN EN 55014-2: 2002-08

You are the owner of a product whose design and construction fulfil the safety aims of the EC for the safe operation of devices.

The approval procedure includes a test of **interference radiation**, i.e. of interference generated by the speed controller. This speed controller has been tested under practical conditions at maximum load current and with a large number of cells, and remains within the interference limits.

A less stringent test would be, for example, to measure interference levels at a low current. In such cases the speed controller would not produce its maximum interference level.

The procedure also includes also a test of **interference susceptibility**, i.e. the extent to which the device is vulnerable to interference from other devices. The test involves subjecting the speed controller to RF signals similar to those produced by an RC transmitter or a radio telephone.

13 Additional features of the future-xxl

This chapter shows the additional features of the *future-xxl-40.303K or -WK* and also of the *future-xxl-40.333K or -WK* in comparison to its predecessor model *future-xxl-40.300K or -WK*.

Following changes are made which mainly refers to the data logging function:

Measuring the motor current

In contrast to its predecessor, whose motor current measuring was not precise enough to display, the *40.303 / 40.333* has some more electronic components to measure the motor current. The new one is relatively precise and has no additional losses (in contrast to a shunt-resistor measurement).

Built-in real time clock

Because of the fact that a lot of measurements can be stored internally, we have added a real time clock to the *40.303 / 40.333* which allows to add a time- and date-stamp on the top of each logging session. So you can find those data - which shall fit to a certain flight (or drive) - very much faster.

The real time clock needs a Lithium battery: **RENATA, 3 V, CR1632, 120 mAh**.

This battery is a special type which is rated for an operating temperature of 85°C.

When this battery is flat, it should be replaced only by this type.

After changing the battery - date and time must be adjusted again.

Setting date and time

For that purpose, as well as for reading the stored data, a connection to the PC has to be established.

When you use the USB device it is not necessary to connect a battery to the controller.

When you are using the 5V-SIO you have to connect a battery with minimum 7.4 volts to the power cables.

The time stamp is stored into the logging data memory every time you connect the controller to the power battery and also appears on the USB and 5V-SIO Port.

* **Date = 2010.06.01 Time = 16:36:46**

If you have to **set the date** you have establish a data connection between *40.303 / 40.333* and **PC**. You can use the Windows standard Hyperterminal or - our recommendation - the Online Window of the Akkusoft (don't forget to select the so called TerminalMode in this online window by using the right mouse button in this window).

Type in a „D“, followed by the year (4-digit); the *40.303 / 40.333* answers with a „.“. Next you have to type-in the month (2-digit), this is also confirmed with a „.“. After that you have to type-in the day (2-digit); this is confirmed by a final „OK“ or „done“.

To **set the time** you have to establish first the data connection between *40.303 / 40.333* and **PC**. To set the date you have to type-in an upcase „T“ followed by the hour (24h format, 2-digit); the hours are acknowledged by a „.“. Next you have to type-in the minutes (2-digit format); these will be also answered by a „.“. Finally you have to set the seconds (2 digits). These will be acknowledged by an „OK“ or „done“.

p.s.: The **Schulze-Soft** has an own button to set DATE and TIME in the *future-xxl*.

future-I, xl, xxl

Power speed controller for brushless and sensorless motors

Operating instructions V 1

Date of issue: 23 JUN 2011



Wiring diagram future-xxl series

Illustration *future-xxl-40.300 / 40.303 K or WK*

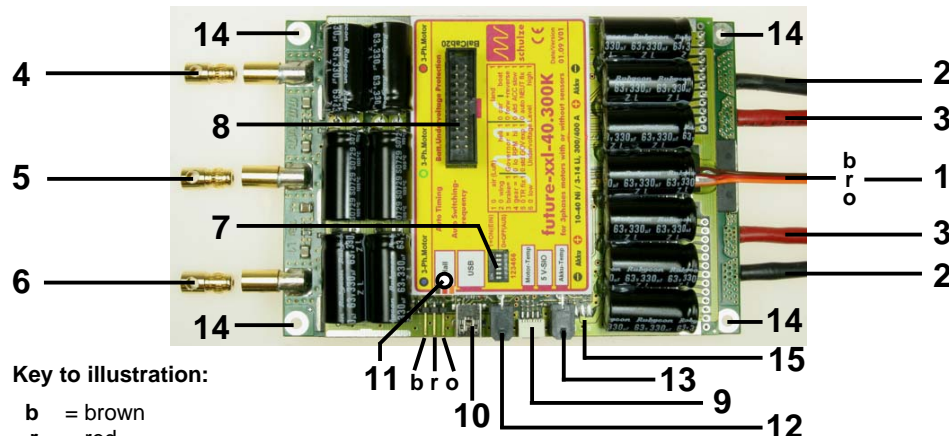

Key to illustration:

b = brown
r = red
o = orange

- 1 Receiver cable, 3-pin:
- 2 Battery connection neg (-) . . black
- 3 Battery connectin pos. (+) . . red

Hint: If you are using the *future-xxl* with two parallel battery cables, these cables must run in pairs (+ and -) to two battery packs; the packs are then wired in parallel in order to achieve maximum current delivery capacity.

- 4 Motor connection* red **(Reverse use blue, black)**
- 5 Motor connection* white, yellow **(Reverse use white, yellow)**
- 6 Motor connection* blue, black **(Reverse use red)**
- 7 DIL switch to select the operating mode
- 8 BalCab20 plug balancing connector - Schulze BalCab20 compatible
- 9 5 V-SIO to read out logger data and for installing firmware upgrades
- 10 USB connector as 9). Also available on splash water protected types.
- 11 HALL input + LED for positioning the airscrew and selecting Aerobatic mode.
- 12 Temperature input To connect the motor temperature sensor
- 13 Temperature input To connect the battery temperature sensor
- 14 Fixing holes Mount the controller always on shock absorbers in the fuselage
- 15 „aldis-HV“ output is activated at full throttle (mounted only if required)

(* Please note the following guidelines, which apply when you are connecting the motor and reversing its direction of rotation:

1 The controller can be used with sensorless and sensor-controlled motors.

If your motor is sensor-controlled, the 5-pin connector is not used.

2.1 The three motor cables can be connected in any order.

2.2 To reverse the direction of rotation you have to swap over two of the three motor cables.

Please read the instructions carefully (including those who hate to read instructions!)

Dear customer,

Congratulations on your choice of a **future-I, -xl or -xxl** speed controller, which is a micro-computer controlled unit developed and manufactured entirely in Germany, designed for brushless and sensorless 3-phase rotary current motors.

All models of the **future** are amongst the world's most powerful speed controllers.

future controllers have the most intelligent, comprehensive software, which means that this speed controller (or governor) is capable of operating virtually any brushless motor currently on the market with optimum efficiency.

The **ips** (intelligent programming system for **future-I, -xl, -xxl**) makes it as simple as possible to configure the controller to match any radio control system and operating mode: The transmitter stick travel settings of the wing programs is fully automatical, the operating modes can easily be configured by the DIL switch.

The **integral motor connector system** is a feature of all **future-I, -xl or -xxl**, and makes it possible to remove the unit for servicing, or for fitting in another model, simply by unplugging the cables - no soldering is required.

Contents

Chapter	Subject	Page
-	Wiring diagrams	1
1	Warning notes, cautions	5
2	Ensuring safe, trouble free operation	6
3	Types, intended applications and common highlights	7
4	Protective circuits	8
5	Monitor displays	9
6	Installing and connecting the unit	10
7	Connector systems and mounting instructions	12
8	Using the controller for the first time	13-21
8.1	ips - the intelligent programming system	13
8.2	Symbols and terminology	14
8.3.1	Mode setting for Wing aircraft models	15
8.3.2	Mode setting for Aerobatic wing models	16
8.3.3	Mode setting for Helicopter models and important tips	17
8.3.4	Mode setting for Car models	20
8.3.5	Mode setting for Boat models	21
9	Tips	22
10	Interfaces	23
11	Interface protocols	24
12	Accessories	25
13	Additional features of the future-xxl	26
14	Legal matters	27
15	Specifications	28
16	Product overview	28

12 Accessories

12.1 *prog-adapt-uni*

Active adapter to connect the **5 V-SIO** of the **future-I, -xl** und **-xxl** (and also the **future-value**) with the RS232 interface (**COMx**) of a PC or Laptop



12.2 *USB-Kabel-mini* (USB-cable-mini)

Adapter cable to connect the mini-USB connector on the **future-I, -xl** and **-xxl** with the USB-connector of a PC or Laptop



12.3 *TempSens-2*

Cable which is equipped with a temperature sensor IC to connect to the temperature measuring inputs of the **future-xxl**



12.4 *TempSens-3*

Cable which is equipped with a temperature sensor IC to connect to the temperature measuring inputs of the **future-I** and **future-xl**

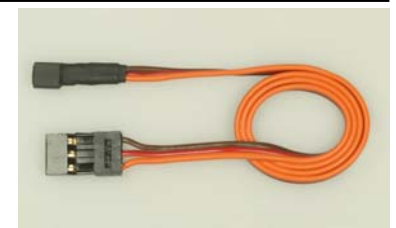

12.5 *mcr-sss*

Cable with a HALL-Sensor (magnetic field sensor) to connect to the Hall-connector on the **future-I, -xl** and **-xxl**. Contains also 3 magnets (Observe polarity. The magnets must be mounted in such a way that their mark is face to face to the marking of the sensor).

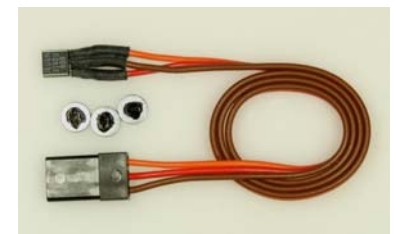

12.6 *aldis-HV*

Alarm display, at present only for the **future-xxl** Picture see chapter 5

11 Communications interface protocols

- 11.1** We do not publish the protocol for the firmware upgrade. We recommend that you use the latest version (V 3.1.0.1 and higher) of **Akkusoft** by Martin Adler.
Note that you need to select the file type **future*.I**, **future*.xl**, **future*.xxl** under Extras -> Firmwareupgrade.
In the **Akkusoft** you have to select the fitting COM port. Since as the USB port is redirected to a virtually COM port you have to read out the used COM port number from the Device Manager** while the **future** is connected to the computer. Note: At first the driver must be installed using our special .inf configuration file (see chapter 10.2). (***) XP: Right-click on MyComputer, Properties, Hardware, Device Manager, COM and LPT ports.
- 11.2** The **5 V-SIO** communications interface communicates at 9600 Baud, no parity, 1 stop-bit, 1 start-bit.
- 11.3** The **USB** communications interface communicates at up to 128 kBaud; this is not affected by the selected baud rate in the **Akkusoft**.
- 11.4** Every time the motor runs, the **future** writes to its memory module (4 Mbyte) at a user-selectable time resolution.
You can read out the logger data via both of the interfaces mentioned above.
Data output commences when the future is connected to the power supply (or USB interface), and the PC picks up a start command. The **Akkusoft** program includes two start buttons for this purpose. **Akkusoft** also allows for the division of the Y-axes in the curve window when you select **future-I**, **-xl**, **-xxl** under Curve Select.
- 11.5** **There are two different data formats: ASCII or SHORT**
The ASCII format is suitable for small amounts of stored data, whereas the SHORT version is better if the data transfer is not to take too long - especially at the 5 V-SIO interface.
- 11.5.1** **ASCII**, ASCII, start command is a lower-case **r**, the transmission format looks like this:Time[sssss.ss], throttle position [%%], current [mA]***, controller temperature[°C], battery pack voltage[mV], (electrical) motor speed[rpm]*, HALL rotational speed[rpm]**, motor temperature[°C], battery temperature[°C], cell1[mV], ..., cell14[mV]. No data output for cells which are not connected.
(*) Motor shaft speed = (electrical) rotational speed output divided by the number of motor pole pairs (an eight-pole motor has four pairs of poles, N/S).
(**) Propeller speed or helicopter main rotor speed = rotational speed output / number of magnets.
(***) fut.-xl-32.202, -xl-40.161, -xl-40.303 only. Other types „0“ (Current = zero). Firmware V5 or higher: A calculated value is displayed (no precise value) when the motor was running the first time with full throttle after the flight/drive battery was changed.
- 11.5.2** **SHORT**, start command is a lower-case **x**, the transmission format consists of max. 24 bytes = 48 nibbles +CR+LF.
Since this format cannot be displayed using a text editor, **Akkusoft** converts the data into the ASCII format when storing the original received data.
- 11.6** **Setting the recording time interval**
For this function Akkusoft includes a button which sends the digits 0, 1, 2, 5 or 9; the default setting is 2 = 200 ms, which equates to 5 data sets per second.
0 = 50 ms, 1 = 100 ms, 2 = 200 ms, 5 = 500 ms, 9 = 1000 ms (1 second).
- 11.7** **Erasing data stored in the future**
Every time you connect the power battery, the **future** ensures that data can be recorded for a period of one hour. If data has to be erased in order to guarantee the one-hour period, it is always the oldest logger data which is deleted. If the most recent recording lasts 15 minutes at 200 ms resolution, the erase process takes about 2.5 seconds before the controller is armed. At twice the resolution, or twice the recording period, the erase process is increased proportionately (i.e. also twice as long). At maximum resolution the process may take up to 40 seconds.
The erase command is an **e**, and **Akkusoft** includes an erase button for this purpose.

1 Warning notes, cautions

Electric motors fitted with propellers are dangerous and require proper care for safe operation. Keep well clear of the propeller at all times when the battery pack is connected.

Technical defects of an electrical or mechanical nature may result in unintended motor runs; loose parts may cause serious personal injury and/or property damage.

The CE-certificate on the speed controller does not absolve you from taking proper care when handling the system!

Speed controllers are exclusively for use in RC models. Their use in man-carrying aircraft is prohibited.

Speed controllers are **not** protected against reverse polarity (+ terminal and - terminal reversed). Connecting the **battery pack** to the **motor leads** of the controller will almost certainly cause irreparable damage.

Electronic equipment is sensitive to humidity. Speed controllers which have got wet may not function properly even after thorough drying. You should send them back to us for cleaning and testing.

Do not use speed controllers in conjunction with a power supply connected to the mains. Energy reversal can occur when the motor slows down and stops, and this may damage the power supply or cause an over-voltage condition which could damage the controller.

Never disconnect the flight pack while the motor is running, as this could cause damage on a speed controller.

Please take care when switching off the receiver battery: depending on the receiver you are using, it may send an incorrect throttle signal to the **future** at this moment, which could then cause the motor to burst into life unexpectedly.

Protect the speed controller from mechanical loads, vibration, dirt and contamination.

Keep the cables to the motor as short as possible (max. length = 10 cm / 4").

Do not exceed the maximum stated length of cable between battery and **future** (max. length: **see chapter 6.3.1**). The wiring inside the battery pack must also be as short as possible. Use in-line soldered "stick" packs. For the same reason, use a clamp-type amperemeter, not a series meter with shunt resistor.

Never leave the flight battery connected when ...
... the model is not in use and/or
... the battery pack is being charged.

Although some speed controllers feature a separate On/Off switch, this does not isolate it completely from the battery.

Speed controllers can only function properly if they are in full working condition. The protective and monitoring circuits can also only work if the speed controller is in good operating condition.

In the case of motor failure (e.g. short circuits in the windings) the over-temperature sensor in the controllers may react too slowly to prevent damage. Switch the motor off immediately to prevent permanent damage to the speed controller.

Note: Please remember that the monitoring circuits are unable to detect every abnormal operating condition, such as a short between the motor cables. Note also that a stalled motor will only trip the current limiter if the motor's stall current is well above the controller's peak current. For example, if you are using an 80 A controller in conjunction with a 20 A motor, the current monitor will not detect an excessive current even when the motor is stalled.

Common information

If you are using a **future** with BEC system then connect on no account a separate receiver battery or an electronic battery switch (two receiver batteries), as this may cause damage to the speed controller and could cause current to flow from the receiver battery to the motor.

2 Ensuring safe, trouble-free operation

Use only compatible connectors. A 2 mm pin cannot provide reliable contact in a 2.5 mm socket. The same applies with 2mm gold-contact pins and 2 mm tin-plated sockets.

Please also remember that ...

... the wiring of your RC-components must be checked regularly for loose wires, oxidation, or damaged insulation.

... your receiver and the aerial must be at least 3 cm (>1") away from motor, speed controller and high-current cables. For example, the magnetic fields around the high-current cables can cause interference to the receiver.

... all high-current cables must be as short as possible. Maximum length between flight pack and speed controller must never exceed the length listed in **chapter 6.3.1**; the length between speed controller and motor should not exceed 10 cm (4") to avoid interferences.

... all high-current cables longer than 5 cm (2") must be twisted together. This applies in particular to the motor power cables, which are very powerful sources of radiated interference.

... in model aircraft: half of the receiver aerial's length should be routed along the fuselage, the other half should be allowed to trail freely (take care not to tread on it). Do not attach the end of the aerial to the fin!

... in model boats: half of the receiver aerial's length should be deployed inside the hull above the waterline, the other half should be threaded into a small tube mounted upright.

Every time you intend to use the power system - before you turn on the receiver - make sure that ...

... no one else is using the same frequency (identical channel number).

... your transmitter is switched on and the throttle stick is (as a rule) in the STOP position (exceptions see Section 9).

Carry out a range check before each flight. Ask an assistant to hold the model aircraft and set the throttle stick to the half throttle position. Collapse the transmitter aerial. Walk away from the model to the distance stated by the RC system manufacturer (this might be a distance of about 50-60 m = 200'). Make sure that you still have full control of the system at this range.

As a general rule: receiver interference is more likely to occur when using a controller with BEC system, as these units do not feature an opto-coupler with its optical link.

When Ni-Cd batteries approach the end of their charge, voltage falls drastically and quickly. The **future** detects this and reduces power to the motor automatically. This should leave sufficient energy to bring your model safely back home. However, if you use a small number of cells of high internal resistance and operate at high motor currents, the controller may reduce power before the pack is discharged. You can eliminate this problem by using low resistance straps to connect the cells, or use the direct cell-to-cell soldering technique ("sticks") and short, heavy-gauge wire if you assemble your own batteries.

Your receiver also benefits from the stability of the voltage supplied from the battery by a BEC system. If the BEC voltage is stable, the receiver is less liable to suffer interference.

The CE symbol is your guarantee that the unit meets all the relevant interference emission and rejection regulations when it is in use.

If you encounter problems operating the **future** controller, please note that many problems are due to an unsuitable combination of receiving system components, or an inadequate installation in the model.

10 Interfaces

10.1 5 V-SIO communications interface

This socket can be used to update the future to the latest firmware version, or to read out the logger data at 9600 Bd. (see also chapter 11.1)

Cable required to connect to PC: **prog-adapt-uni**

10.2 USB communications interface

This socket can be used to update the future to the latest firmware version, or to read out the logger data at up to 128 KBd. (see also chapter 11.1)

Cable required to connect to PC: **USB-Kabel-mini**

Driver file required for the PC: **schulze-future-l-xl-xxl-64bit.inf**

(You will find it in our USB driver download section **C 4** on our Homepage).

10.3 HALL sensor input

10.3.1 This socket can be used to connect a HALL sensor (for detecting magnetic fields). If you connect the HALL sensor and glue a magnet to the spinner or the propeller (with correct polarity - see **chapter 12.5**; check LED on **-xxl** glows when controller is not armed), then a useful function can be exploited when the controller is set to fixed-wing model aircraft mode: when the brake is activated, the motor will stop and remain for a few seconds with the sensor directly over the magnet. (Note: only possible in a natural locking position of the motor). Typical applications are to place the propeller of a glider's folding motor vertical, so that the pylon can retract cleanly, or to fold the blades of a glider's folding propeller horizontally, so that the model does not land on one propeller blade.

Sensor set: **mcr-sss** (consisting of **mcr-sens** and **mcr-mag**)

10.3.2 The Hall sensor socket can also be used to ascertain the actual shaft speed of a motor (one magnet on the propeller) or a helicopter rotor (usually three magnets on the main gear). The signals are stored in the logger data sets as a rotational speed value.

10.3.3 Bridging the outer two pins of the three-pole socket activates the aerobatic fixed-wing aircraft program in the Car setting (see Chapter 8.3.2). The best way to do this is to modify an unwanted servo lead: remove the centre wire, then cut the two outer wires very short, strip the insulation, solder them together and insulate the joint. Don't bridge two adjacent pins, as this can result in a short-circuit which could damage the speed controller.

10.4 Motor temperature sensor input

To measure the temperature of an in-runner (!) motor, the sensor can be glued to the outside of the motor case.

10.4.1 Temperature sensor for **future-l** and **-xl** : **TempSens-3**

This is connected to the three-pole pin-row located on the top of the controller between the motor sockets: the brown wire must line up with the centre motor phase.

10.4.2 Temperatursensor für **future-xxl** : **TempSens-2**

This should be connected to the rear two-pole socket (on the side, located close to the motor terminals) and locked in place.

10.5 Battery temperature sensor input

Wherever possible, position the sensor on the centre (or better: in the centre) of the battery for measuring battery temperature.

10.5.1 Temperature sensor for **future-l** and **xl** : **TempSens-3**

This is connected to the three-pole pin-row on the underside of the controller, located between the motor sockets: the brown wire must line up with the centre motor phase.

10.5.2 Temperatursensor für **future-xxl** : **TempSens-2**

This should be connected to the front two-pole socket (on the side, located close to the battery terminals) and locked in place.

9 Tips

9.1 Start-up problems, controller / governor faults

We have now established that the usual cause of unreliable motor start-up problems is poor contact in the connectors.

Inadequate contact can result in faults due to excessive voltage, especially when the high-voltage versions of the **future** are used, because the high resistance of the connectors prevents the voltage being passed back into the battery at mid-range settings, and especially during braking.

9.1.1 Examples of poor practice and their remedies

- **Solder between the contact segments of the plug**
 - Remedy: solder on a brand-new plug.
- **Resin (electronic solder flux) under the contact segments of the plug**
 - Remedy: remove flux residues with meths or contact cleaner.
- **Over-long leads between battery and future**
 - Remedy: shorten to permissible length (chapter 6).
- **Lack of spring pressure in the contact segments**
 - Remedy: solder on brand-new plugs, and be sure to cool the contact spring when soldering (or remove them carefully before soldering).
- **Poor-quality connectors.** Oxidised sockets (black inside), discoloured gold plating (greenish or grey), weak contact springs.
 - Remedy: use high-quality plugs and sockets from a brand-name manufacturer
 - Remedy: don't use cheap goods from the Far East
 - Remedy: contact springs shld be made of copper-beryllium - not from mild steel!

9.2 Overheating motors

Never shorten the winding wires which project from the motor. The strands are coated with high-temperature lacquer, and it is impossible to solder through this material. To obtain a sound soldered joint you must mechanically remove the lacquer coating all round each individual strand. Any strands which are not soldered or fractured cause an increase in current flow through each remaining wire, and this in turn causes a lower efficiency and increase in motor temperature.

9.3 Interferences

We recognized some interference in combination with certain types of motors. These interferences occurs in combinations with different manufacturers of controllers.

9.4 Multi motor operation

In general terms we do not recommend operating multiple motors with a **future**. From some of our customers we have heard that this certainly works with some (but not all) Aveox, Hacker, Kontronik or Lehner motors, provided that the currents do not exceed the permissible maximum values for the speed controller concerned. However, we cannot guarantee that both motors will rotate over the full load range.

It is never permissible to run more than one Plettenberg or Köhler (Actro) motor connected to a single **future**: you must use a separate **future** for each motor. However, you can certainly power both controllers from a single drive battery - provided that you use short power leads and/or inline soldered batteries in a cup.

3 Types, intended applications and common highlights

Common Highlights

Almost all of this **future-I, -xl, -xxl** controllers are universal types which can be used in **model aircraft, helicopters, boats and cars**. They includes an opto-coupler which ensures minimum possible transfer of interference to your receiver.
Warning: A by-passed opto-coupler by an external BEC can lead to interference problems.

The **future-I and -xl** controllers are designed with a relatively big PCB with a lot of copper on the inner layers. It is used as a cooling plate which distributes and dissipates the heat which especially rises in part throttle use.

„K“-Types:

All **future-I and -xl** controllers with a single "K" in the type designation feature a finned heat-sink. This unit is an excellent choice for use under part-load conditions, i.e. operating them primarily at part-throttle settings does not lead so quickly to overheating, even with high cell counts.

„WK“-Types:

These types are protected by a dipping varnish. Depending on the type they are equipped with one (-I) or two water cooling tubes (-xl). The **-xxl** is equipped with an aluminium cooling block with a sequence of internal tightly contiguous cooling windings.

- „Auto-arm“ function and „power on reset“.
- **Up to 2048-step resolution** over the whole control range for extremely fine speed control.
- **RC-Car programm** with proportional brake.
- **RC-Car- and boat-programm** with reverse gear (can be additionally switched on).
- „ips“ (intelligent programming system) with no pots! The speed controller uses - depending on the operating mode - fixed throttle positions or automatically configures itself every time to the stick travel when you go airborne.
- **During** the "Power-On" process the motor acts as a loudspeaker to give you audible confirmation of the procedure.
- **Connectors** (sensors not included): 2 temperature sensors, HALL-sensor, 5V-SIO, USB (not at „W“-types).
- **Schulze BalCab20** balancing cable connector to monitor the single cells in a lithium battery pack. When this connector is not connected then the throttle is decreased when the pack voltage reaches about 59 % or 66 % of the connecting voltage at all battery types.

Types overview

future-I

future-I-24.150WK

For 10-24 Nickel- or 3-8 Lithium-cells.
150 A full throttle for 3 Ah, 200 A for 10 sec.
By the cooling water connection and the additional splash-water protection the speed controller is particularly applicable in boats and cars.

future-I-32.115

For 10-32 Nickel- or 3-10 Lithium-cells.
115 A full throttle for 3 Ah, 150 A for 10 sec.

future-I-32.115WK

As above. By the cooling water connection and additional splash-water protection the controller is particularly applicable in boats and cars.

future-I-40.100

For 10-40 Nickel- or 3-14 Lithium- cells.
100 A full throttle for 3 Ah, 133 A for 10 sec.

future-I-40.100WK

As above. By the cooling water connection and additional splash-water protection the controller is particularly applicable in boats and cars.

future-xl

WK-Types: By the cooling water connection and the splash-water protection the speed controller is particularly applicable in boats and cars.

future-xl-32.200WK / 32.202WK

For 10-32 Nickel- or 3-10 Lithium- cells.
200 A full throttle for 3 Ah, 260 A for 10 sec.

future-xl-40.160 / 40.161 (WK)

For 20-40 Nickel- or 4-14 Lithium- cells.
160 A full throttle for 3 Ah, 210 A for 10 sec.

future-xxl

future-xxl-40.300K / 40.303K or WK

For 12-40 Nickel- or 4-14 Lithium- cells.
330 A full throttle for 3 Ah, 440 A for 10 sec.

future-xxl-40.300WK / 40.303WK

By the cooling water connection and the splash-water protection the speed controller is particularly applicable in boats and cars.

4 Protective circuits

Note: the monitor circuits are effective, but they cannot detect every possible operating condition.

4.1 Temperature monitors

4.1.1 The temperature monitor for the power MOSFETs and the PCB throttles down the motor and later switches off the motor. You can reset the unit using the "auto-arm" function (throttle stick to stop for about 2 sec.)

If the motor windings are short-circuited the temperature monitor reacts too slowly to prevent damage. Switch the motor off immediately to avoid permanent damage to the speed controller.

4.1.2 The temperature monitor, operating via the external sensors, throttles the motor back to 50% of power (helicopter: to 90% of the set nominal rotational speed) in order to warn the user that the temperature is excessive. The default limits are 100°C for motor temperature, and 70°C for battery temperature.

4.2 Voltage monitor

As soon as the voltage of the drive battery falls back to the under voltage threshold the motor is throttled back (more information about the threshold value see **chapter 8.9**).

If the situation which caused the controller to throttle back continues for more than a short time, the unit switches the motor off.

Of course, you can re-start the motor again briefly by moving the throttle stick back to "stop" for about 2 seconds to re-arm the system.

In this situation you retain full control of the model until the receiver battery is flat.

4.3 Current Monitor

The **future** controllers feature a current monitor circuit which trips when the current rises above the specified maximum value. If the motor is stalled, the motor is throttled back. This means, that a motor which draws an excessive current will never reach full-throttle, and the current may stay below the specified maximum value. If **future** is a short time in current limiting mode, it will disarm itself (switching off the motor). Re-arming = apply 2 seconds "stop".

4.4 Maximum rotational speed monitor

If maximum rotational speed of the motor will exceed, **future** throttles down. In this state do not use longer than 1 second. After 2 seconds at maximum speed the motor is switched off.

Because of this: Do not run motor without air-screw.

4.5 Minimum rotational speed monitor

To ensure that the controller detects the rotor position reliably, this series of **future** types sets a defined minimum rotational speed.

This protective function can cause the motor to be reluctant to start up or even to a refused start if its torque limit is exceeded.

If this should happen, check also under full throttle that the maximum permissible motor current is not exceeded. In this case a more lightweight propeller and/or one step smaller in diameter must be used.

4.6 Operation with only two motor phases connected

If you attempt to operate a motor with only two phases connected, the controller detects after a brief period that the motor is unable to follow. Nothing happens, and no connection melody is emitted.

If one motor connector comes adrift in use, the future disarms itself within milliseconds.

4.7 Reverse polarity protection

These speed controllers are not protected against reversed polarity!

4.8 Receiver signal monitor

If the receiver signal fails, or the signal is longer or shorter than the usual range of values, the smart controller reverts to hold mode for about 300 milliseconds (helicopter = 1.5 s) before switching to disarmed mode.

This warning function enables you to eliminate receiver interference before you actually lose your model, perhaps by modifying the installation or changing the radio control components

4.9 Watchdog

If this circuit is tripped the speed controller stops working briefly and then reverts to normal operation.

8.3.5 Mode setting boat models

DIL switch # 1 = 1 = land

DIL switch # 2 = 1 = boat

DIL switch # 3 = 0 = Forward only, reverse gear off.
1 = Forward and reverse gear.

DIL switch # 4 = 0 = Short soft start for fast acceleration
1 = Smoother soft start

DIL switch # 5 = 0 = Learning „neutral“ position (neutral +- 0,3 ms)*
1 = Fixed throttle positions (1,2 / 1,5 / 1,8 ms)**

DIL switch # 6 = 0 = LiPo empty level 3.0 V / cell or 59 % of c.v.
1 = LiPo empty level 3.3 V / cell or 66 % of c.v.

- a Receiver off (drive battery disconnected)
- b1* Set stick to centre position (for forward/reverse use) or
- b2* Set stick to end position (stop, for double stick travel)
- c Switch transmitter on
- d Switch receiver on and connect drive battery
- e **future** confirms „Power-On“, waits about 1 second and
- f1* calculates full throttle and reverse position (when DIL switch # 5 = 0)
- f2* or calculates only full throttle position (when DIL switch # 5 = 0)
- g confirms neutral position with a single beep and is armed!
- h Moving the transmitter stick towards full throttle starts the motor running forward
- i Moving the transmitter stick towards reverse gear the boat slow down
- j **If reverse gear is enabled** (DIL sw. # 3 = 1) **and b1* or **:**
If you leave the stick in the reverse position (over 75% reverse travel, i.e. less than 0.225 ms below the learned neutral position) for longer than 1.2 seconds, the boat will accelerate slowly in reverse.

(* b1, f1) full-brake = neutral - 0,3 ms; full throttle = neutral + 0,3 ms

(* b2, f2) Neutral position is learned; full throttle = neutral + 0,6 ms

(**) full-brake = 1,2 ms; neutral = 1,5 ms; full-throttle = 1,8 ms

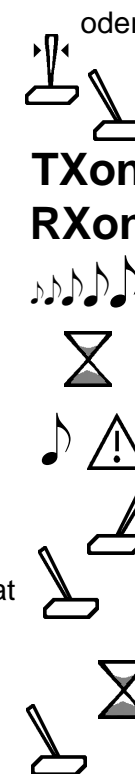

8.3.4 Mode setting car models

DIL switch # 1 = 1 = land

DIL switch # 2 = 0 = car

DIL switch # 3 = 0 = Forward only, reverse gear off.
1 = Forward and reverse gear.

DIL switch # 4 = 0 = Short soft start for fast acceleration
1 = Smoother soft start for less grip

DIL switch # 5 = 0 = Learning „neutral“ position (neutral +/- 0,3 ms)*
1 = Fixed throttle positions (1,2 / 1,5 / 1,8 ms)**

DIL switch # 6 = 0 = LiPo empty level 3.0 V / cell or 59 % of c.v.
1 = LiPo empty level 3.3 V / cell or 66 % of c.v.

- a Receiver off (drive battery disconnected)
- b Set transmitter stick to centre position (1.4 ... 1.67 ms)
- c Switch transmitter on
- d Switch receiver on and connect drive battery
- e **future** plays „Power-On“ tune...
- f ...waits about 1 second and calculates the full throttle and full brake position (when DIL switch # 5 = 0),
- g confirms neutral position with a single beep and is armed!
- h Moving the transmitter stick towards full throttle starts the motor running forward
- i Moving the transmitter stick towards full brake slows the model proportionally
- j **If reverse gear is enabled:** If you leave the stick in the reverse position (more than 75% reverse travel, i.e. less than 0.225 ms below the learned neutral position) for longer than 1.2 seconds, the car will accelerate slowly in reverse.

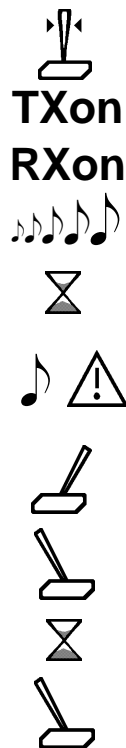

(*) full-brake = neutral - 0,3 ms; full-throttle = neutral + 0,3 ms

(**) full-brake = 1,2 ms; neutral = 1,5 ms; full-throttle = 1,8 ms

4.10 Beep-Codes

Under certain circumstances **future** controllers refuses to work after connection to the power battery and beeps - if possible - an error code:

4 beeps:

battery weak (empty or high impedance) or battery cables too long. (Remedy e.g. by adding low ESR electrolytic capacitors with fitting tension and capacity near the **future** - see picture below)

5 beeps:

motor too strong or short circuit in the windings.

6 beeps:

double tone beep, normal beep, double tone... (motor defective, battery weak, **future** defective)

Remedy when the **future** beeps 4 times

How to mount additional blocking capacitors:

The electrolytic capacitors should be from the same type, same capacity and also the same tension as equipped on the **future**.

Glue capacitors together as shown in the picture, bend legs to the right (to the left), solder them together. Add a reinforce lead to the neg. and to the pos. pole each. Strip the isolation in a distance of about 5 cm from the controller on a length of 5 mm and tin the core. Wind overhanging leads around the battery leads and solder them tight. Fix leads with tape and/or heat shrinking tube.

Hint: By means of the additional capacitors the anti-spark circuit is inoperative.

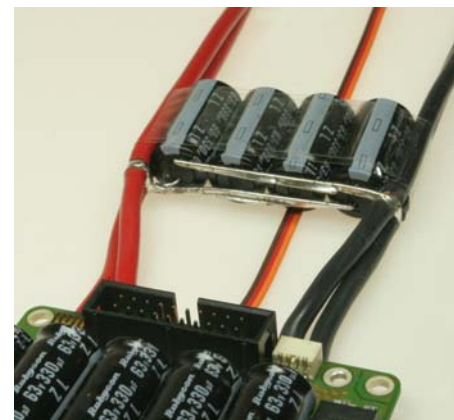

5 Monitor displays

5.1 The **future** is not fitted with LED to indicate its operating state.

5.2 However, when the unit is being configured the set stick end-points are confirmed by a beep from the motor or a barely perceptible "blip" in full-throttle position when normal using with activated brake. (See also the corresponding section 4.10 or 8).

5.3 **aldis** connection (alarm display)

When printing the manual only available on the **future-xxl**.

THE useful aid to optimising the power system, also "flat battery" warning and high temperature indicator This is a panoramic LED array consisting of red LEDs, usable with 10...32* / 40** Ni-cells or 3...10* / 14** Li-cells, designed to be mounted on the underside of the helicopter in any clearly visible position.

We can retro-fit the connection provided that the circuit board is suitable (or you can do it, but no guarantee claims; **take care:** the flight battery voltage is present at this connection).

This connection always becomes active if ...

5.3.1 ... the motor reaches full-throttle (in "governor" mode this means: I cannot maintain the rotational speed, i.e.: motor + gearbox + collective pitch angle = incorrectly matched; **or:** battery flat, land immediately) and

5.3.2 ... the **future** detects overheating (**aldis** comes on at around 90°C and goes out again at around 80°C).

(*) Previous **aldis**: max. 42 volts

(**) New: **aldis-HV**: max. 60 volts

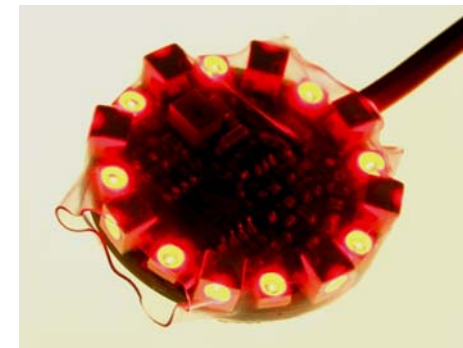

6 Installations, connections

6.1 Receiver connection

Connect the (3-wire) receiver cable attached to the **future** to the receiver servo output corresponding to the throttle stick on the transmitter (or a switch if that is your preference).

The **future** receives its control signal via this receiver socket.

Hint: Because of the fact that the **future** is not equipped with a BEC system and the control pulses from the receiver is led through an electrically insulating opto-coupler to the **future** your receiver and the servos are in need of a receiver battery to work as expected.

6.2 Installing in the fuselage

Velcro (hoop and loop) tape is the ideal method of mounting the **future-I oder -xl** controllers in the fuselage. Of course they also can be mounted on shock absorbers.

The **-xxl** should be mounted exclusively on shock absorbers in the fuselage.

It is essential to use shock absorbers of adequate length (height), otherwise the circuit board may suffer mechanical damage, and this may then result in electrical damage.

Do not pack the **future** in foam as this may lead to a heat build-up in the controller.

6.3 Connecting the battery

6.3.1 Cable length battery <--> future

Do not exceed the maximum stated length of cable between battery and **future**, otherwise the speed controller may be damaged.

This rule still applies even if your power system features a retractable (folding) motor, or your model necessarily includes a long battery cable!!! Especially most of the lithium battery packs with odd cell count or round cells which are assembled in a zig-zag pattern also produce "long cable" effects. Use in-line (end-to-end) soldered packs exclusively.

The maximum cable lengths inside the battery pack plus the length between the battery pack and the PCB of the **future** are as follows:

fut-I: (14") 35 cm red, 35 cm black

fut-xl: (10") 25 cm red, 25 cm black

fut-xxl: (14") 35 cm red, 35 cm black

6.3.2 Selecting appropriate connectors / wiring battery packs in parallel

It is essential to select connectors whose maximum load capacity is appropriate to the motor's current drain and the battery's maximum discharge rate.

For this reason virtually all **future-I, -xl** and **-xxl** types are fitted with two pairs of battery cables.

The **future-I-40.100(WK)** is the sole type which is connected adequately using only single 6 mm connectors and a battery capable of delivering up to 100 A.

8.3.3.7 Pre-set of the rotor speed

To provide finer control of the pre-set rotor speed, set up the slider channel on the transmitter so that the full-throttle end-point corresponds to the maximum rotor speed you ever need (e.g. for aerobatics). You can achieve this by reducing servo travel, and/or adjusting the neutral point. It is usual to use a 3-position toggle switch (motor off / hover / cruise) or better: Autorotation / hover- / cruise and a separate OFF-switch if you wish to use fixed rotational speeds.

8.3.3.8 Note to the configuration

Fixed stick positions means: idle (off) = 1.1 ms, full throttle = 1.9 ms. If you are using a Graupner RC system this equates to +/- 100% stick travel. If you find that you cannot arm the controller reliably, the solution is to increase servo travel to about 105%...110%.

In speed regulator mode the full throttle setting on a slider should be different - according to the maximum rotational speed you require - and is not necessarily 100%.

Important: If you are using the **future** as a normal speed controller (not as a governor) in your helicopter, you must connect the future's servo cable to the receiver output which puts out the throttle curve set on the transmitter when you operate the collective pitch control.

If you are using the **future** as a speed regulator (governor), you must not connect the controller to the receiver channel which puts out the throttle curve. Instead connect it to a channel which is controlled directly by a slider or rotary control on the transmitter, i.e. a channel not affected every time by the collective pitch control. If you ignore this, motor speed will change every time you give a collective pitch command.

8.3.3.9 Helicopter motors (efficiency / temperature)

For helicopter applications the motor's maximum efficiency should be around 15 A - 20 A for scale / hovering / normal flights. When the main use is 3-D, then the max. efficiency should be at currents of about 30 - 40 amperes.

8.3.3.10 Rotational speed fluctuations in governor mode (const. rpm)

• The first step is to test the **future** in standard constant speed mode and/or in standard speed controller mode (not constant speed mode). Test it if the air is not smooth. If tail oscillation occur, the gyro is incorrectly set up, and/or the tail rotor servo is too slow, and/or the tail rotor control mechanism and/or the helicopter chassis is not rigid enough.

There must be absolutely no play in the sliding sleeve linkage, the blades, the ballraces in the sleeve and in the tail rotor blades.

• If the transmission includes a belt drive, especially in the main rotor system, the belt must be adequately tensioned.

• Receiver interference may affect the nominal rotor speed, and cause fluctuations in rotational speed. In "normal controller" mode this interference is not usually detectable. Please use a PCM-receiver or -of course- **a schulze alpha-receiver**.

• Please mount the gyro directly on the tailboom, not in or on the chassis.

8.3.3.1 Common to the helicopter mode

- **Fixed stick positions:** Idle (off)=1,1 ms, full throttle=1,9 ms
- **Slow initial motor start** up to 10 seconds

8.3.3.2 Explanatory notes regarding rotational speed range

The number of poles in the motor can be viewed as a supplementary electrical "reduction gearbox". For a given pre-set electrical rotational speed an eight-pole motor (shaft) turns four times as slowly as a two-pole motor, and a four-pole motor turns at half the speed of a two-pole type. This means: if you set the **future** for an (electrical) nominal rotational speed of 28,000 rpm, a two-pole motor will spin at 28,000 rpm (by definition this also applies to the motor shaft), but a four-pole motor will turn at only 14,000 rpm (at the motor shaft), while an eight-pole motor spins at only 7000 rpm (at the motor shaft). The two rotational speed ranges therefore cover all the motors and reduction ratios used in model helicopters.

8.3.3.3 Selecting the (electrical) rotational speed range

The low rotational speed range is generally used for two-pole motors or low-speed four-pole motors. If your motor has six or more poles you can always use the high speed range. If in doubt, carry out an experiment to find the optimum operating mode - always starting with the low speed range. If the maximum possible rotational speed is sufficient for aerobatic flying, then you have found the correct mode. If not, select the high range.

8.3.3.4 Setting the (electrical) speed ranges in the transmitter (relating to 2-pole motors)

The pulse widths of the throttle channel is linear divided to the travel of the throttle slider. (The approx. % values are relating to the servo travel of the mc18...mc24 transmitters)

Low r.p.m.: Slider at pulse width: 1.16 ms (-84,5%)= 3250 rpm, 1.9 ms (+100%)= 29500 rpm

High r.p.m.: Slider at pulse width: 1.16 ms (-84,5%)=13000 rpm, 1.9 ms (+100%)= 118000 rpm

8.3.3.5 Examples

Example 1: Logo600 HACKER C50-18XL with 13 teeth pinion and 8s (3-D setup)

Low r.p.m., 1500 rpm = +16 %, 1900 rpm = +49 %

Example 2: Logo600 Pletti Orbit 30-12 Heli Expert with 15 teeth pinion and 8s (normal setup)

High r.p.m., 1400 rpm = +18 %, 1650 rpm = +40 %

Example 3: Logo600 Pletti Orbit 30-12 Heli Expert with 15 teeth pinion and 10s (3D setup)

High r.p.m., 1600 rpm = +36 %, 2000 rpm = +71 %

Example 4: Joker Köhler Actro 32-3 with 20 teeth pinion and 10s LiPo

High r.p.m., 1350 rpm = -3 % 1600 rpm = +16 %

Example 5: Acrobat Shark Kontronik Pyro 30-12 with 20 teeth pinion and 12s LiPo

High r.p.m., 1500 rpm = +32 %, 2000 rpm = +69 %

Hint: A %-calculation program „**HeliCalc**“ is available on our Homepage at the download section **C1**.

8.3.3.6 Setting the auto-rotation function

If operation of the auto-rotation switch at the transmitter triggers a mixer which reduces the throttle channel to the pulse width corresponding to minimum rotational speed, then you can interrupt an auto-rotation descent at any time simply by operating the auto-rotation switch again, as this returns the system to the previously set rotational speed.

In this case a much faster soft-start is employed when the motor speeds up, instead of the initial ten-second soft-start.

Note: program the auto-rotation setting to about 1.15 ms, rather than "motor off". In the case of Graupner radio control systems this corresponds to -87.5%.

If you were to program a genuine "motor off" signal (less than 1.14 ms) for the throttle channel when auto-rotation is selected, it would be almost impossible to interrupt an auto-rotation descent since the initial ten-second soft-start would be triggered again.

If higher currents are used, the battery packs must be wired in parallel.

When using the **future-I or -xl** the easiest method of accomplishing this is to fit each pair of cables with a pair of **4 mm polarised connectors**. Take care to maintain correct polarity (Chapter 7).

If you are using the **future-xxl** types this procedure is not sufficient due to the maximum discharge rates of standard commercial battery packs. For this reason more than two packs should be wired in parallel, and these should be connected using **6 mm polarised connectors**.

Connectors which do not have a polarised insulator can be made safe (i.e. polarised) by soldering the **future's** positive battery wire to a socket, and the **future's** negative wire to a plug.

We recommend that you choose your connectors using the right power rating from our selection in Section 7 - fitting any other type of connector invalidates the warranty.

6.3.3 Connecting the balancer cable

If you are using a battery with a Schülze **BalCab20** socket, all you need to complete the connection is a **Bal-Cab20-Verl**.

If two packs of this type are wired in parallel, then the pack with the weakest cell (assuming that you know which this is) should be connected to the balancer socket of the **future**. Otherwise you also need a **LiPoDiMATIC-SE14**.

If your battery is fitted with a different balancer connector, you can use our **BalCab20-Set**, fit an adapter or use **LiPoDiMATICS** with the appropriate connectors.

The connection of the BalCab20 socket (balancing connector of the battery) must be connected before power cables of the **future** are connected to the battery. Only in this chronological order the single cell monitoring is active. Firmwareversion **V 3.20** or higher allows the activation of the single cells monitoring a little bit later: when you apply throttle for the first time.

6.4 Connecting the motor

The cables to the motor should be kept as short as possible to avoid interferences to your receiver. Long cables tend to act as aerials and radiate interference; they also add unnecessary weight (see also section 2). Long cables should be twisted. Carry out the range check with the motor running at half-throttle. Check motor temperature during this test! Some motors grow hotter at long duration half throttle than at full throttle.

Cut down the existing motor cables to a length of no more than 10 cm. Do not extend the motor cables except in exceptional cases; although this generally does not harm to the **future** itself.

Under no account is it allowed to wind ferrite cores on the motor wires!

Locate the cables with the pp60 plugs supplied with the controller (plugged into the integrated motor sockets of the **future**), and solder them to the motor cables. Observe solder instructions in section 7.2. See cover sheets (page 1-3) for details of cable configuration.

Avoid pulling on the motor cables; we recommend that you secure the three motor plugs with glass-reinforced or fabric tape to prevent them being pulled out.

7 Connector systems and mounting instructions

7.1 CT4, 4 mm gold-contact connector system; rating up to 80 A

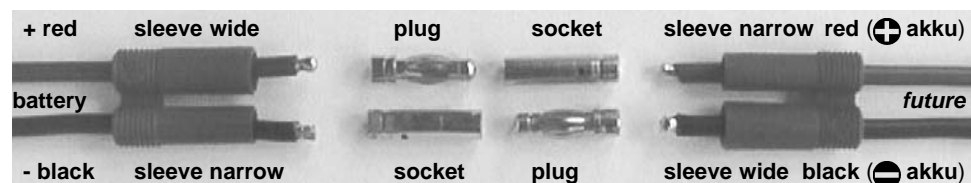

Fit the connectors in the order shown above; the contacts are pressed in as follows:

- Rest plastic sleeve on vice jaws with cables hanging down.
- Close vice jaws until cables are just free to move.
- Fit plug into socket and tap into sleeve until latch engages.
- Fit socket onto plug and tap into sleeve until latch engages.

7.2 pp60L, 6.0 mm gold contact system; rating up to about 150 A

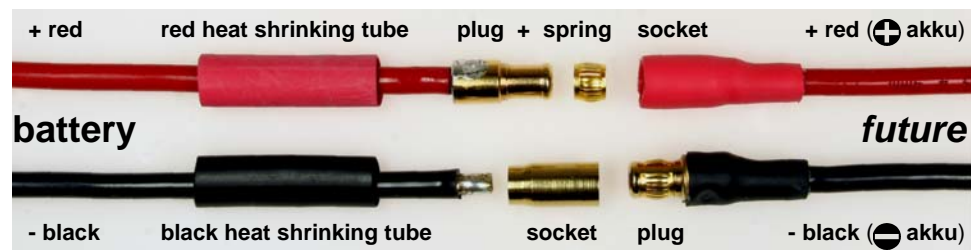

Fit the connectors in the order shown above:

- Strip the isolation from the leads, twist wires, tin them.
- Remove contact spring carefully with a pair of tweezers from the core of the plug to avoid over heating them.
- Solder plugs and sockets to the leads. Observe polarity (i.e. the colours of the leads) and the contact type (i.e. if male or female).
- Shrink heat shrinking tube segments as shown in the right part of the picture.
- Mount the contact spring again on its place.

8.3.3 Mode setting helicopter models

DIL switch # 1 = 0 = air

DIL switch # 2 = 1 = heli (helicopter)

DIL switch # 3 = 0 = Normal controller. Use throttle via pitch curve!
1 = Governor mode. RPM is constant at varying loads.

DIL switch # 4 = 0 = Low r.p.m. range*
1 = High r.p.m. range*

DIL switch # 5 = 0 = Regulator constants: Standard mode
1 = Regulator constants: Expert mode

DIL switch # 6 = 0 = LiPo empty level 3.0 V / cell or 59 % of c.v.
1 = LiPo empty level 3.3 V / cell or 66 % of c.v.

- Receiver off (flight battery disconnected)
- Set pitch stick to „minimum pitch“
- In speed governor mode only** (DIL switch # 3 = 1):
Move slider resp. toggle switch to „motor off“ position
- Switch transmitter on
- Switch receiver on (connect flight battery)
- future* plays „Power-On“ tune...
- ...waits about 1 second, confirms idle position with a single beep and is armed!
- Model is ready to launch, keep clear of danger area around rotor blades!
- In speed governor mode only** (DIL switch # 3 = 1):
Move slider very quickly (or set toggle switch) in direction of hovering throttle to set the rotor speed you require and wait until the rotor has reached the set value
- Move the transmitter stick towards hovering position, the helicopter can be flown
- (*) See annotations in chapter 8.3.3.1+ on the next pages



TXon

RXon

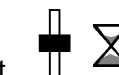

8.3.2 Mode setting aerobatic wing aircraft models with proportional brake

DIL switch # 1 = 1 = land (!)

DIL switch # 2 = 0 = car (!)

Jumper-bridge on the HALL-input pin 1+3 (brown+orange or black+white)

DIL switch # 3 = 0 = Normal controller
1 = Throttle regulation at decreasing battery voltage

DIL switch # 4 = 0 = Short soft start for direct drive
1 = Smoother soft start for belt drive gearbox

DIL switch # 5 = - = The throttle stick travel is always fixed:
full brake = 1.0 ms, neutral = 1.5 ms, full throttle = 2.0 ms

DIL switch # 6 = 0 = LiPo empty level 2.5 V / cell or 59 % of c.v.
1 = LiPo empty level 3.3 V / cell or 66 % of c.v.

a Receiver off (flight battery disconnected)

b Set throttle stick to brake position

c Switch transmitter on

d Switch receiver on and connect flight battery

e *future* plays the „Power-On“ tune...

f ...waits about 1 second, then confirms brake position with a single beep and is armed!

g The *future* is completely configured!

h Put model in launch position, keep clear of danger area around propeller!

i Apply throttle with the throttle stick.

j The model can be flown.

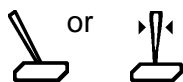

TXon

RXon



8 Initial use

8.1 ips, the intelligent programming system

for configuring the *future-I*, *-xl*, *-xxl* to suit your application

8.1.1 If you have a transmitter with adjustable servo travel we recommend that you set throttle-servo to normal full travel, i.e. +/- 100%. Adjust Multiplex servo center pulse width to 1.5 ms (= -22% center or use uni-mode).

8.1.2 The DIL switch bank of the *ips* allows to config the controller to various applications. It is not necessary to use any other aids (PC, programming PCB).

8.1.2.1+2 The DIL-switches 1 and 2 are used to select the operating mode.

Extensive information and explanations can be found on the following pages.

8.1.2.3 Activating the brake, the governor mode or the reverse gear*

8.1.2.4 Smooth start time or the range of the governor RPM regulation*

8.1.2.5 Automatic adjustment to the mechanical transmitter stick travel or the use of the fixed given stick pulse width für e.g. neutral, full brake, full reverse and/or full throttle*

8.1.2.6 Selection of the under voltage limit of the pack or cell tension

(*) depending on the selected operating mode.

Explanations re 8.1.2.5 - DIL-switch No. 5 = OFF

The stick travel setup process is based on the previous standard procedure when the unit is first switched on, and is fully automatic:

8.1.2.5.1 Under normal circumstances you simply proceed as previously: 1. Transmitter to stop, 2. Switch on receiver, 3. Connect flight pack / drive battery (*future* confirms this with "Power-On" tones = flight pack / drive battery connected), then learns the Stop position and confirms this with a beep; it is then armed, 4. Hold model in launch / start position, 5. Apply full-throttle (*future* learns full-throttle point, confirms with brief drop in rotational speed), 6. Launch / Start model. The process configures both the brake point and the full-throttle point, so full stick travel is always available when you operate the motor, giving ultra-fine control.

8.1.2.5.2 If you find the brief motor speed drop at the full-throttle setting disturbing (confirmation of learned full throttle position), or don't wish to apply full throttle at launch / start, there is an alternative method: set the transmitter stick to the full-throttle position before you switch on the receiving system and connect the flight pack / drive battery. After the "Power-On" tones the *future* emits two beeps (to confirm it has learned the full throttle position); the transmitter stick is then moved to Stop, and the *future* emits one beep (to confirm it has learned the brake position); the controller is now armed, and the model can be launched or started at any throttle position.

8.1.2.5.3 In the model car and boat programs the controller only learns the neutral point; the full-throttle position is a fixed margin from the learned neutral point.

8.1.2.5.4 In the helicopter programs the stick travels cannot be configured by the user. The neutral and full brake and full-throttle settings are fixed.

Explanations re 8.1.2.5 - DIL-switch No. 5 = ON (e.g.: stop = 1,1 ms, full throttle = 1,9 ms)

The full brake-, neutral- and full throttle positions are fixed.

In all operating modes the controllers work as described in chapter 8.1.2.5.4.

When you want to exploit the full travel of the transmitter stick to vary motor speed, it could be possible that you program a slight reduction in servo travel at the transmitter.

Caution: If you reduce servo travel too far, full throttle will not be available, and the controller will not reach the Stop setting, and therefore will not reach the armed state!

8.1.3 If your *future* beeps twice (double beep = full throttle position) when the transmitter stick is at the brake position, you must reverse the throttle channel using your transmitter's servo reverse function. If you neglect to do this, the *future* will be armed (single beep) at the transmitter's full-throttle setting, and run at full-throttle at the stop setting, which is not recommended!

8.2 Symbols and terminology

Stick: The throttle stick on the transmitter

Neutral position (self neutralising stick, 1.36 ... 1.67 ms pulse width)
Idle position (position where the motor just barely runs) or stop position (brake).



Brake position or idle position: (equivalent to e.g. 1.1 ms pulse width)
Position of the throttle stick where the motor stops or just barely runs.



Full-throttle position: (equivalent to e.g. 1.9 ms pulse width)
100% voltage passed to the motor.



Wait (e.g. 1 second)



Audible indicators:

These indicators are only audible when a motor is attached, as the motor itself acts as the loudspeaker.

Power-On melody (Flight-/drive battery connected)



Single beep (Brake position detected/learned, future is armed)



Double beep (Full throttle position detected/learned, future not armed)



Momentary interruption in running (full throttle position learned while running)



c.v. = connecting voltage

The controller measures and stores the battery voltage when the battery pack is connected to the controller. This value is stored unchanged until the pack is separated from the battery.

8.3.1 Mode setting wing aircraft models

DIL switch # 1 = 0 = air

DIL switch # 2 = 0 = wing

DIL switch # 3 = 0 = brake off
1 = brake enabled

DIL switch # 4 = 0 = short soft start for direct drive + planetary gear
1 = smoother soft start for belt drive gearbox

DIL switch # 5 = 0 = learns throttle stick travel automatically
1 = uses fixed stick positions (1,1 ms - 1,9 ms)

DIL switch # 6 = 0 = LiPo empty level 3.0 V / cell or 59 % of c.v.
1 = LiPo empty level 3.3 V / cell or 66 % of c.v.

a Receiver off (flight battery disconnected)

b Set throttle stick to brake position

c Switch transmitter on

d Switch receiver on and connect flight battery

e **future** confirms by playing the „Power-On“ tune...

f ...waits about 1 second, confirms brake position with a single beep and is armed!

g Hold model in launch position, keep clear of danger area around propeller!

h* Move throttle quickly to full-throttle position and ...
... leave it there for about 1 second (motor is running!)

i* **future** confirms full-throttle position by interrupting the motor run very briefly - a barely perceptible "blip"

j The **future** is completely configured and the model can be flown

(*) When „**DIL-switch # 5 = 1**“ then it is not necessary to apply full throttle at „**h**“. The blip at „**i**“ is omitted.



TXon

RXon

